

# Educational Tracking Camera

RGB20X-NAI-GY

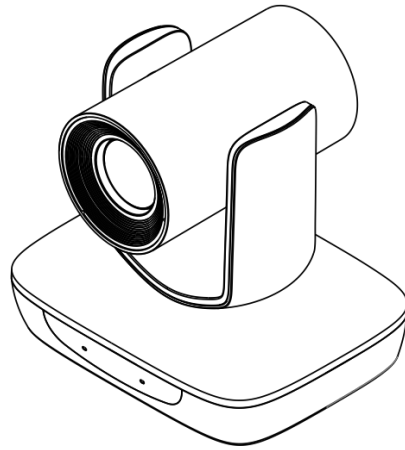

## User Manual

**RGBlink**<sup>®</sup>



---

# Content

<b>Declarations.....</b>	<b>4</b>
FCC/Warranty.....	4
Operators Safety Summary.....	5
Installation Safety Summary.....	5
<b>Chapter 1 Your Product.....</b>	<b>6</b>
1.1 In the Box.....	6
1.2 Product Overview.....	6
1.2.1 Interface.....	7
1.2.2 Dimension.....	10
<b>Chapter 2 Install Your Product.....</b>	<b>11</b>
2.1 Installation.....	11
2.1.1 Desktop Mount Installation.....	11
2.1.2 Wall Mount Installation(Optional).....	11
2.2 Connection.....	12
<b>Chapter 3 Use Your Product.....</b>	<b>13</b>
3.1 Remote Controller.....	13
3.2 Menu.....	15
3.2.1 Menu Settings.....	15
3.2.2 Menu Explanation.....	17
3.3 Network Connection.....	21
3.3.1 LAN Connection.....	21
3.3.2 WAN Connection.....	21
3.4 Client Software Instruction.....	23
3.4.1 Search and List the Camera.....	23
3.4.2 Preview.....	24
3.4.3 Settings.....	25
<b>Chapter 4 Ordering Codes.....</b>	<b>28</b>
4.1 Product.....	28
<b>Chapter 5 Support.....</b>	<b>29</b>
5.1 Contact us.....	29
5.2 Trouble Shooting.....	30
<b>Chapter 6 Appendix.....</b>	<b>31</b>
6.1 Specification.....	31
6.2 VISCA Protocol List.....	32
6.2.1 Camera Return Command.....	32
6.2.2 Camera Control Command.....	33
6.2.3 Inquiry Command.....	36
6.3 Pelco-D Protocol Command List.....	37

---

6.4 Pelco-P Protocol Command List.....	38
6.5 Terms & Definitions.....	39
6.6 Revision History.....	44

---

Thank you for choosing our product!

This User Manual is designed to show you how to use this video processor quickly and make use of all the features. Please read all directions and instructions carefully before using this product.

## Declarations

### FCC/Warranty

#### Federal Communications Commission (FCC) Statement

This equipment has been tested and found to comply with the limits for a class A digital device, pursuant to Part 15 of the FCC rules. These limits are designed to provide reasonable protection against harmful interference when the equipment is operated in a commercial environment. This equipment generates, uses, and can radiate radio frequency energy and, if not installed and used in accordance with the instruction manual, may cause harmful interference to radio communications. Operation of this equipment in a residential area may cause harmful interference, in which case the user will be responsible for correcting any interference.

#### Guarantee and Compensation

RGBlink provides a guarantee relating to perfect manufacturing as part of the legally stipulated terms of guarantee. On receipt, the purchaser must immediately inspect all delivered goods for damage incurred during transport, as well as for material and manufacturing faults. RGBlink must be informed immediately in writing of any complains.

The period of guarantee begins on the date of transfer of risks, in the case of special systems and software on the date of commissioning, at latest 30 days after the transfer of risks. In the event of justified notice of compliant, RGBlink can repair the fault or provide a replacement at its own discretion within an appropriate period. If this measure proves to be impossible or unsuccessful, the purchaser can demand a reduction in the purchase price or cancellation of the contract. All other claims, in particular those relating to compensation for direct or indirect damage, and also damage attributed to the operation of software as well as to other service provided by RGBlink, being a component of the system or independent service, will be deemed invalid provided the damage is not proven to be attributed to the absence of properties guaranteed in writing or due to the intent or gross negligence or part of RGBlink.

If the purchaser or a third party carries out modifications or repairs on goods delivered by RGBlink, or if the goods are handled incorrectly, in particular if the systems are commissioned operated incorrectly or if, after the transfer of risks, the goods are subject to influences not agreed upon in the contract, all guarantee claims of the purchaser will be rendered invalid. Not included in the guarantee coverage are system failures which are attributed to programs or special electronic circuitry provided by the purchaser, e.g. interfaces. Normal wear as well as normal maintenance are not subject to the guarantee provided by RGBlink either.

The environmental conditions as well as the servicing and maintenance regulations specified in this manual must be complied with by the customer.

---

# Operators Safety Summary

The general safety information in this summary is for operating personnel.

## Do Not Remove Covers or Panels

There are no user-serviceable parts within the unit. Removal of the top cover will expose dangerous voltages. To avoid personal injury, do not remove the top cover. Do not operate the unit without the cover installed.

## Power Source

This product is intended to operate from a power source that will not apply more than 230 volts rms between the supply conductors or between both supply conductor and ground. A protective ground connection by way of grounding conductor in the power cord is essential for safe operation.

## Do Not Operate in Explosive Atmospheres

To avoid explosion, do not operate this product in an explosive atmosphere.

# Installation Safety Summary

## Safety Precautions

For all product installation procedures, please observe the following important safety and handling rules to avoid damage to yourself and the equipment.

To protect users from electric shock, ensure that the chassis connects to earth via the ground wire provided in the AC power Cord.

The AC Socket-outlet should be installed near the equipment and be easily accessible.

## Unpacking and Inspection

Before opening product shipping box, inspect it for damage. If you find any damage, notify the shipping carrier immediately for all claims adjustments. As you open the box, compare its contents against the packing slip. If you find any shortages, contact your sales representative.

Once you have removed all the components from their packaging and checked that all the listed components are present, visually inspect the system to ensure there was no damage during shipping. If there is damage, notify the shipping carrier immediately for all claims adjustments.

## Site Preparation

The environment in which you install your product should be clean, properly lit, free from static, and have adequate power, ventilation, and space for all components.

---

# Chapter 1 Your Product

---

## 1.1 In the Box

Power Adapter × 1

RS232 Serial Cable × 1

Remote Control × 1

## 1.2 Product Overview

### Key Features

- Built-in industry-leading body detection and lock tracking image algorithm
- 1/2.8 inch CMOS sensor, 2.14 megapixel
- 20X optical zoom, Max FOV: 59.5°
- Support HDMI, 3G-SDI, Network, USB, up to 1080P60 video output
- 1 channel audio LINE IN, AAC Compression
- Support two modes of power supply, POE power supply or adapter power supply
- Support VISCA interface and protocol, support flow control
- Dual stream
- Support NDI®|HX

## 1.2.1 Interface

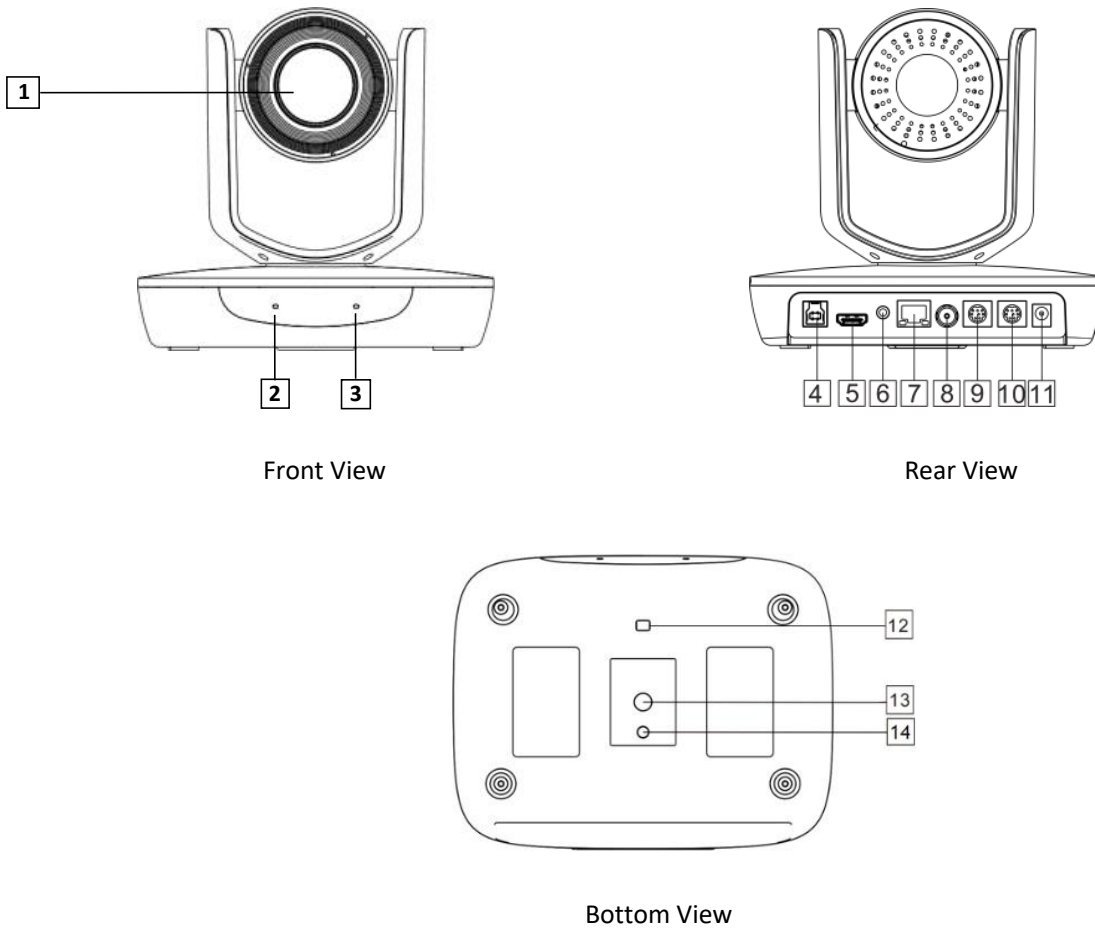

1. Camera
2. Communication indicator
3. Power indicator
4. USB port
5. HDMI video output port
6. LINE IN port
7. Network port
8. SDI port
9. RS-232IN/IR port
10. RS-232OUT/RS-485 port
11. Power(DC12V)
12. DIP switch:set camera video format and menu
13. Mounting hole:1/4" inch screw thread for fixing camera
14. Locating hole:to define installation direction of camera

## RS232 Pin Definition:

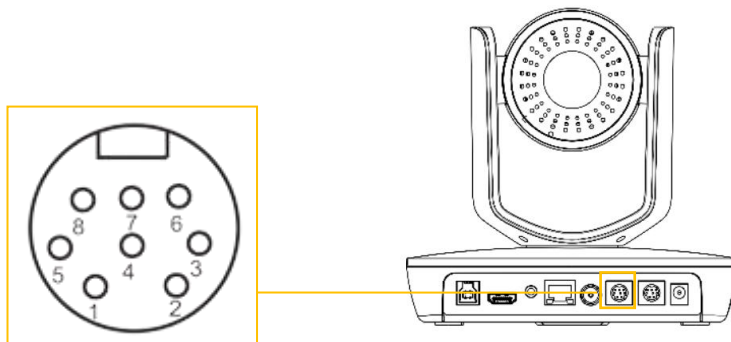

RS-232IN/IR Pin Definition	
Number	Definition
1	/
2	/
3	232-TX
4	GND
5	232-RX
6	GND
7	IR
8	/

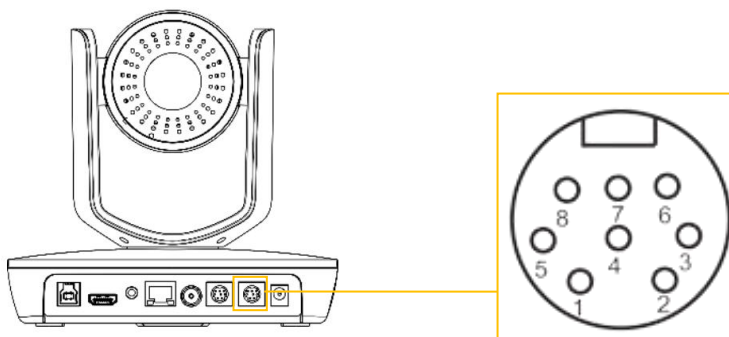

RS-232OUT/RS-485 Pin Definition	
Number	Definition
1	/
2	/
3	232-TX
4	GND
5	232-RX
6	GND
7	485+
8	485-



## DIP Switch Settings

Before installing and operating the camera, set video output format and menu through DIP switches. The camera has two 4-digit DIP switches. SW as below:



SW Settings:

No 1~4 is used to set video output format and menu. Refer to below chart for details:

SWITCH NO.	SW			
	1	2	3	4
1080P25	OFF	ON	ON	ON
1080P30	ON	OFF	ON	ON
720P50	OFF	OFF	ON	ON
720P60	ON	ON	OFF	ON
1080i50	OFF	ON	OFF	ON
1080i60	ON	OFF	OFF	ON
1080P50	OFF	OFF	OFF	ON
1080P60	ON	ON	ON	OFF
MENU	ON	ON	ON	ON



Note:PTZ reboot is necessary for the new setting to take effect.

## 1.2.2 Dimension

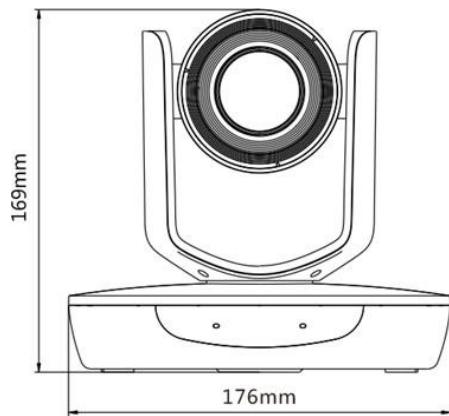

Front View

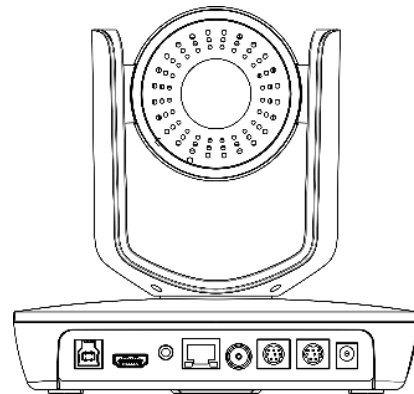

Rear View

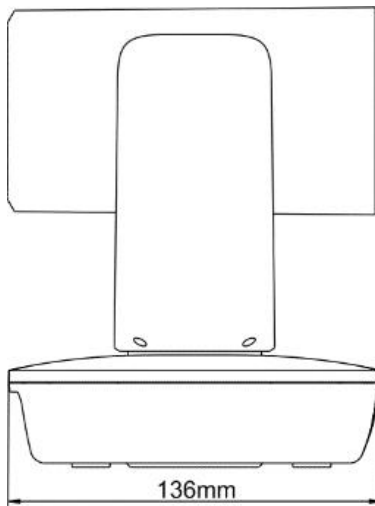

Side View

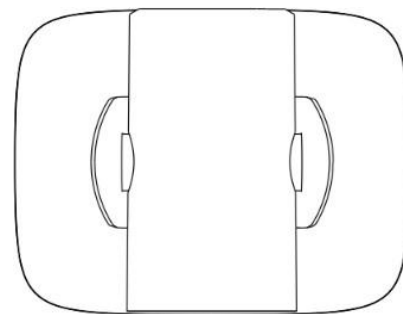

Top View

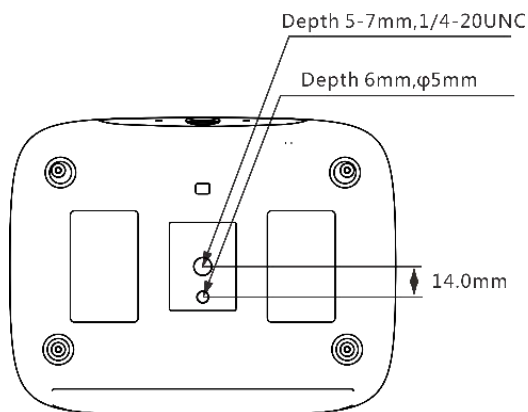

Bottom View

---

# Chapter 2 Install Your Product

---

## 2.1 Installation

The camera has 2 installation types: desktop and wall mount installations (optional).



Note: Make sure the installed place is strong and safe enough to hold the camera and relative parts, it is suggested that the installed place can withstand 4 times the weight of the camera and its relative parts.

### 2.1.1 Desktop Mount Installation

1. Put the camera on a flat surface. In case the camera has to be placed on an inclined surface, make sure the cline angle is less than 15 degrees to ensure proper pan /tilt operation.

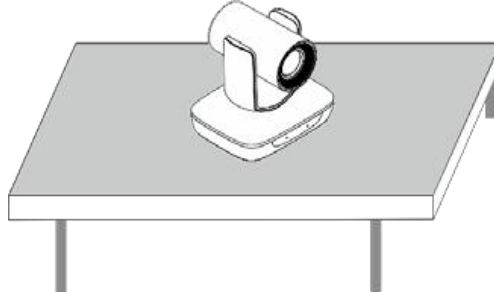

Note: 1. Take effective measures to avoid camera from dropping.

2. Do not grab the camera head when carrying.
3. Do not rotate the camera head with hand. It may cause malfunction to the camera

### 2.1.2 Wall Mount Installation(Optional)

1. According to diameter and position of the 4 installation holes (As shown below) on the bracket, drill 4 holes on the wall and fix the bracket onto the wall by using 4 screws which should be prepared by you.

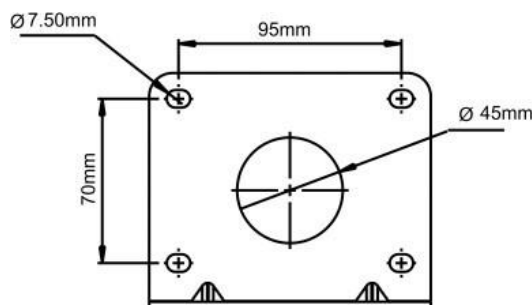

2. Before fixing the camera, set the DIP switches of the camera correctly.
3. Use inch screws to fix the camera on the bracket, fix the limit screw according to actual requirement, and make sure the camera is tightly fixed onto the bracket before your hands leave the camera.

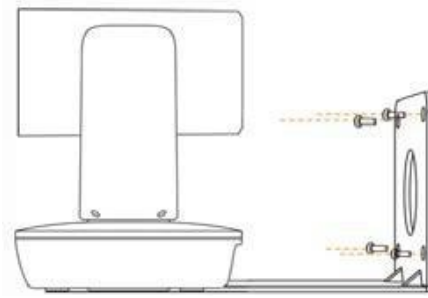

## 2.2 Connection

Check the wiring connection (as shown below) before turn on the camera.

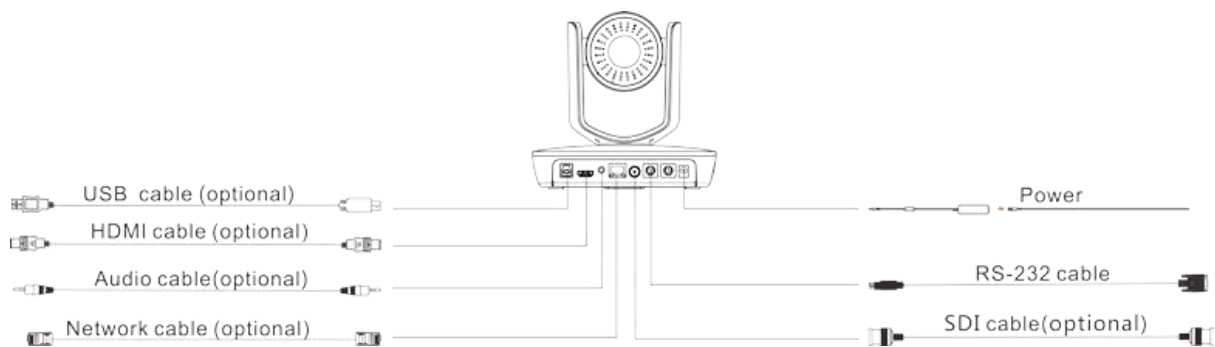

Note: If preset 0 has been saved, after powered on, camera moves to preset 0 automatically; if preset 0 has not been saved, after powered on, camera moves to Home position, where both pan and tilt angle is zero and zooming time is 1x.

# Chapter 3 Use Your Product

## 3.1 Remote Controller

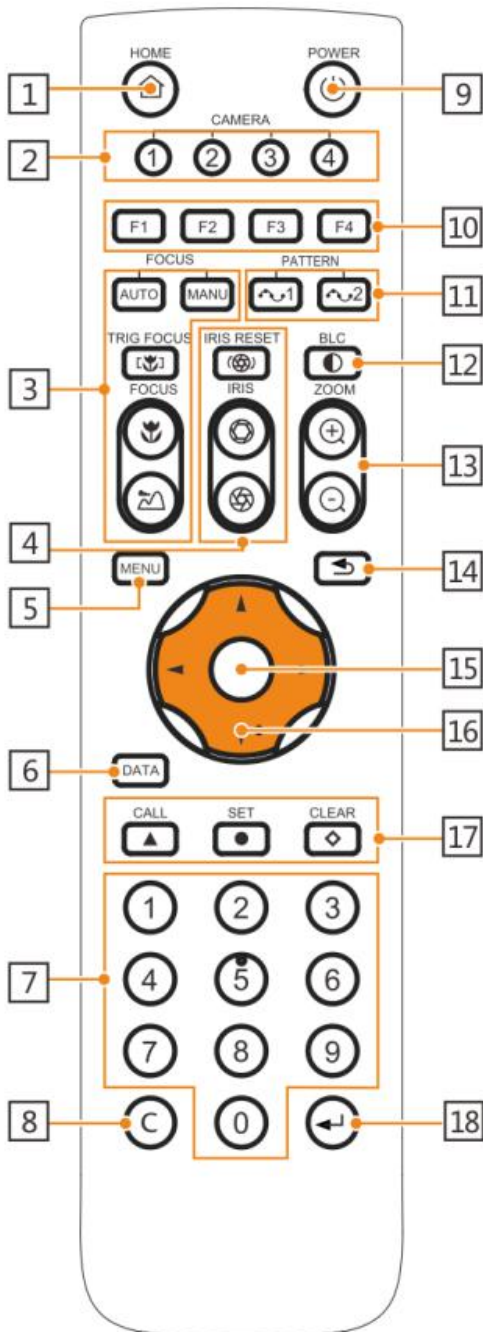

### 1 . HOME

Press HOME button,camera moves to initial position.

### 2. Camera Selection Button

Used to switch among 4 cameras,press 1-4 number buttons to control cameras with 1-4 addresses respectively. For example,press button 1 to control the camera with address 1.

### 3. Focus

Press “AUTO” button to switch to Auto Focus, press “MANU” button to switch to Manual Focus mode.

“”button to Focus Near

“”button to Focus Far

“”button to Auto Focus once every time it is pressed, then switch back to Manual Focus mode.

### 4. Iris

Press“”button to reset iris (image brightness) value to default. “”button to Iris Open (brighter image)

“”button to Iris Close (darker image).

### 5. Menu

Press MENU button to enter/exit menu.

### 6. Data

Reserved

### 7. Number Keys

Used to input numbers, for example, preset number.

### 8. Cancel

To cancel numbers input

### 9. Power

After the camera has been connected to power source, in none-menu status, press this button to turn on / off the camera.

---

## 10. Reserved Buttons(F1,F2,F3,F4)

Reserved

## 11. Pattern

Reserved

## 12. BLC

Used to open / close back light compensation.

## 13. Zoom

Used to adjust zooming times. “⊕ –Zoom in”; “⊖ –Zoom out”

## 14. Back

Press ↶ button to go back to previous menu.

## 15. OK

In None-menu status: press this button to switch among pan / tilt control speeds.

In Menu status: get into relative menu option after it has been selected.

## 16. Direction / Menu Operation

In None-menu status, press these four buttons to pan left/right and tilt up/down.

In Menu status: ▲ or ▼ button to select among menu options, ◀ or ▶ to change option / value.

## 17. Preset Setting

“▲” button to call a preset. Input number key(s), and then press this button to call a preset.

“●” button to set a preset. Move the camera to a specific position, adjust focus value and etc, and then press this button to set a preset.

“◇” button to clear a preset. Input number key(s), and then press this button to clear a preset.

## 18. Enter

After inputting numbers, press this button to confirm.

# 3.2 Menu

## 3.2.1 Menu Settings

<VIDEO>	IMAGE MODE	STAND,MIRROR
	SHARPNESS	0, 1, 2, 3, 4, 5, 6, 7, 8, 9, 10, 11, 12, 13, 14,15
	BRIGHENESS	0, 1, 2, 3, 4, 5, 6, 7, 8, 9, 10, 11, 12, 13, 14
	CONTRAST	0, 1, 2, 3, 4, 5, 6, 7, 8, 9, 10, 11, 12, 13, 14
	GAMMA MODE	0, 1, 2, 3, 4
	2DNR LEVEL	1, 2, 3, 4, 5, OFF
	3DNR LEVEL	1, 2, 3, 4, 5, OFF
	WIDE DYNAMIC	1, 2, 3, 4, 5, OFF

<EXPOSURE>	MODE	FULL AUTO		
		MANUAL	GAIN	0, +2, +4, +6, +8,+10, +12, +14, +16,+18,+20,+22,+24,+26,+28, +30
			SPEED	1/25,1/50, 1/75, 1/100, 1/120, 1/150,1/215,1/300,1/425, 1/600,1/1000,1/1250, 1/1750,1/2500,1/3500, 1/6000,1/10000
			IRIS	F14,F11,F9.6,F8,F6.8,F5.6,F4.8, F4,F3.4,F2.8,F2.4,F2,F1.6,OFF
		SHUTTER PRI	SPEED	1/25, 1/50, 1/75,1/100, 1/120,1/150,1/215,1/300, 1/425,1/600,1/1000, 1/1250, 1/1750,1/2500, 1/3500, 1/6000,1/10000
	IRIS PRI	IRIS	F14,F11,F9.6,F8,F6.8,F5.6, F4.8,F4,F3.4,F2.8,F2.4,F2,F1.6, OFF	
	BRIGHT PRI	LEVEL	0, 1, 2, 3, 4, 5, 6, 7, 8, 9, 10, 11, 12, 13, 14, 15, 16, 17, 18, 19, 20, 21, 22, 23, 24,	

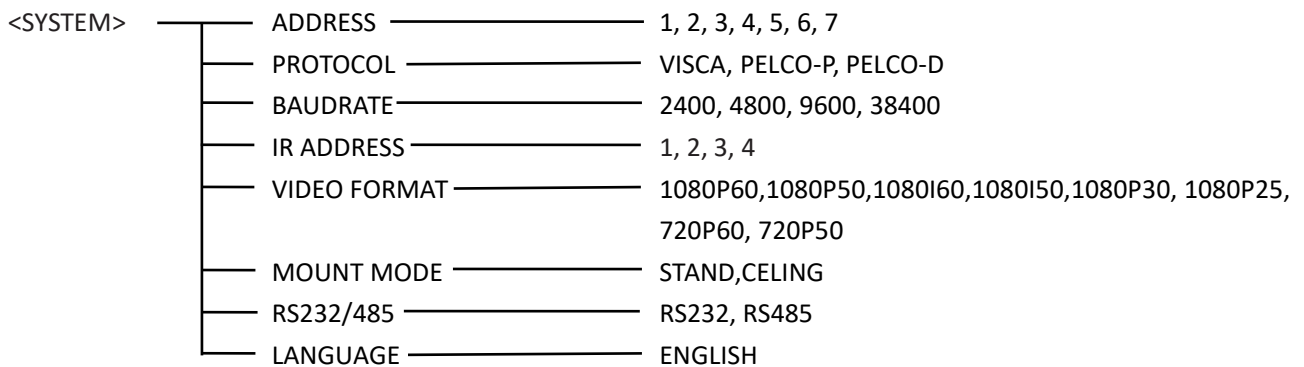
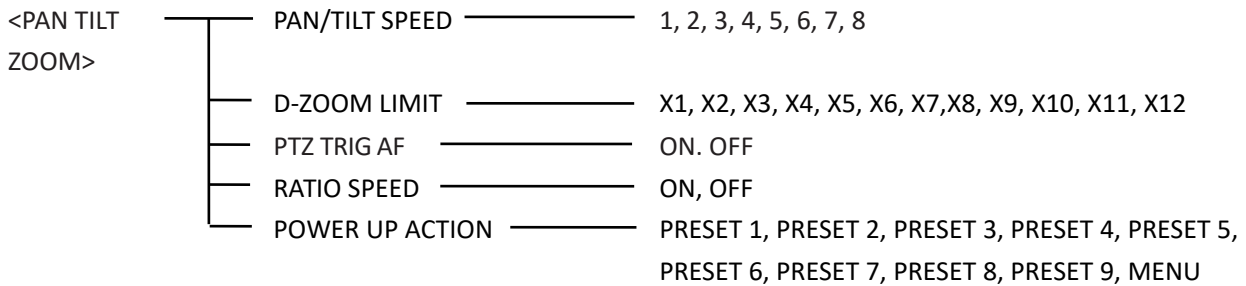
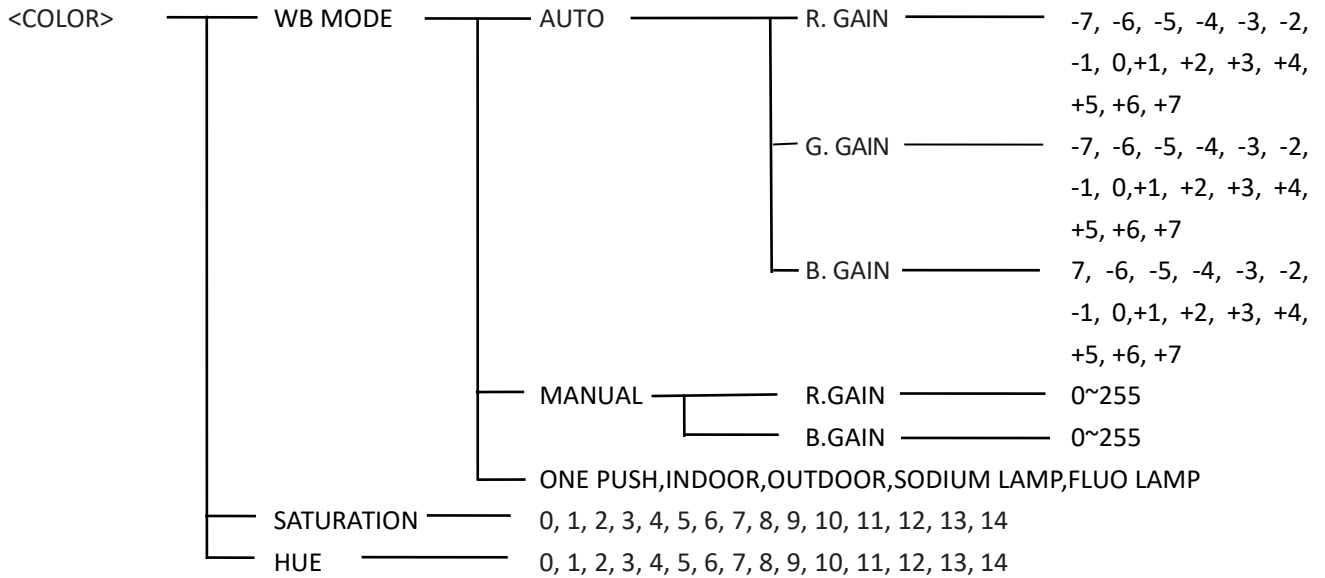
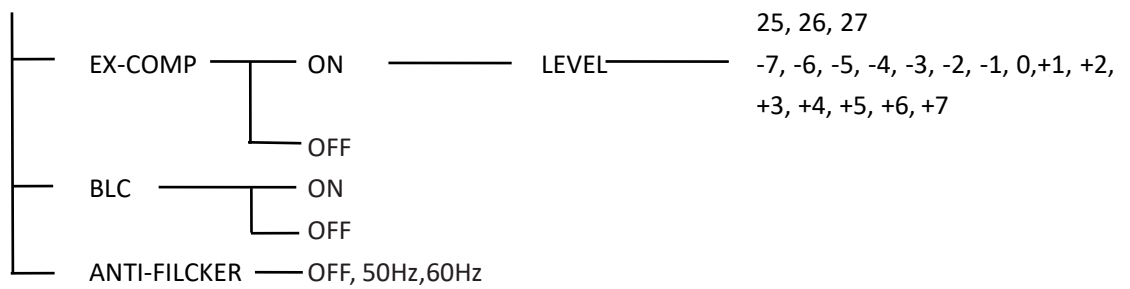



<STATUS>	ADDRESS	1
	PROTOCOL	VISCA
	BAUD RATE	9600
	IR ADDRESS	1
	VIDEO FORMAT	1080P25
	MOUNT MODE	STAND
	FIRMWARE VER	V1.0.37

<RESTORE DEFAULT>

### 3.2.2 Menu Explanation

#### Main Menu

Main Menu Call Preset #95 to enter menu

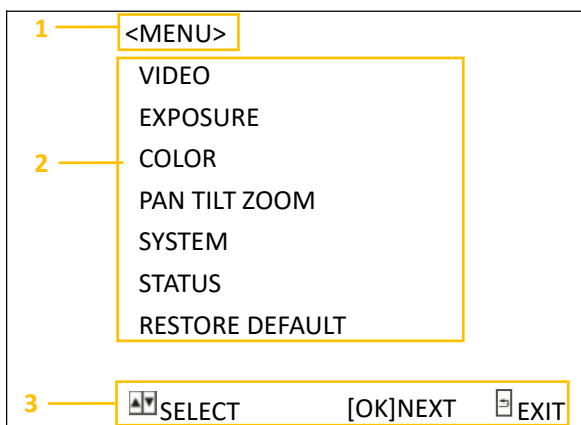

##### 1. Menu Title

It displays currently selected menu option

##### 2. Menu Options

It displays options under current menu title.

Click UP or DOWN button to select among menu options, once color of options turned to different color, it indicates the menu has been elected, click IRIS+ button to get into this menu.

##### 3. NEXT/EXIT

#### Sub Menu

From main menu, navigate to select <EXPOSURE> menu, click IRIS + to enter.

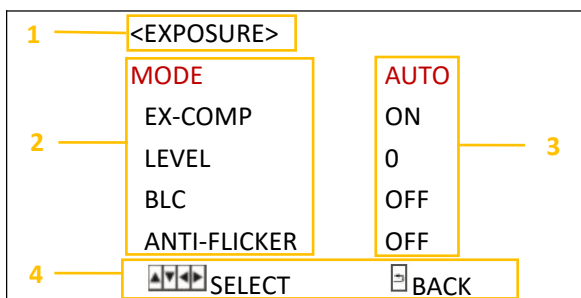



1.2 Please refer to the same controls to the Main Menu.

##### 3. Menu Options

Click ◀ or ▶ to change the values.

## Video

VIDEO menu is used to change video value.

<VIDEO>	
<b>IMAGE MODE</b>	<b>STAND</b>
SHARPNESS	8
BEIGHENESS	7
CONTRAST	2
GAMMA MODE	0
2DNR LEVEL	OFF
3DNR LEVEL	OFF
WIDE DYNAMIC	OFF
 SELECT	 BACK

### Available Options:

**IMAGE MODE:** STAND MIRROR

**SHARPNESS:** 0, 1, 2, 3, 4, 5, 6, 7, 8, 9, 10, 11, 12,13, 14, 15.

**BRIGHRNESS:** 0, 1, 2, 3, 4, 5, 6, 7, 8, 9, 10, 11,12, 13, 14.

**CONTRAST:** 1, 2, 3, 4, 5, 6, 7, 8, 9, 10, 11,12, 13, 14.

**GAMMA MODE:** 0, 1, 2, 3, 4.



**2DNR LEVEL:** 1, 2, 3, 4, 5, OFF.

**3DNR LEBEL:** 1, 2, 3, 4, 5, OFF.

**WIDE DYNAMIC:** 1, 2, 3, 4, 5,OFF.

## Exposure

EXPOSURE menu is used to adjust exposure value.

<EXPOSURE>	
<b>MODE</b>	<b>FULL AUTO</b>
EXP-COMP	ON
LEVEL	0
BLC	ON
ANTI-FLICKER	OFF
 SELECT	 BACK

### Available Options:

**FULL AUTO:** Gain, Shutter Speed and Iris value are adjusted automatically accordingly to working environment.

**MANUAL:** manually adjust Gain, Shutter Speed and Iris.

**GAIN:** 0, +2, +4, +6, +8, +10, +12, +14,+16, +18, +20, +22, +24, +26, +28, +30.

**SPEED:** 1/25, 1/50, 1/75, 1/100, 1/120, 1/150, 1/215, 1/300, 1/425, 1/600,1/1000, 1/1250, 1/1750, 1/2500, 1/3500, 1/6000, 1/10000.

**IRIS:** F14, F11, F9.6, F8, F6.8, F5.6, F4.8,F4, F3.4, F2.8, F2.4, F2, F1.6, OFF

**SHUTTER PRI:** Gain and Iris value are adjusted automatically according to working environment; shutter speed value is adjustable manually.

**SPEED:** 1/25, 1/50, 1/75, 1/100, 1/120, 1/150, 1/215, 1/300, 1/425, 1/600, 1/1000,1/1250, 1/1750, 1/2500, 1/3500, 1/6000,1/10000.

**IRIS PRI:** Gain and shutter speed value are adjusted automatically according to working environment; Iris value is adjustable manually.

**IRIS:** F14, F11, F9.6, F8, F6.8, F5.6, F4.8,F4, F3.4, F2.8, F2.4, F2, F1.6, OFF.

**BRIGHT PRI:** Manually adjust the video brightness.

**BRIGHT:** 0, 1, 2, 3, 4, 5, 6, 7, 8, 9,10, 11, 12, 13, 14, 15, 16, 17, 18, 19, 20,21, 22, 23, 24, 25, 26, 27.

**EXP-COMP:** Once EXP-COMP is set as On, below level options become available: -7, -6,-5, -4, -3, -2, -1, 0, +1, +2, +3, +4, +5, +6,+7. +7 is the maximum compensation value for bright, -7 is the maximum compensation value for dark.

**BLC:** ON, OFF



Backlight compensation (BLC) is video gain done automatically to correct the exposure of subjects that are in front of a bright light source.

**ANTI-FLICKER (OFF, 50Hz, 60Hz)**

To avoid video flicker at power systems of different frequency.

## Color

COLOR menu is used to adjust color related values. Available options:

<COLOR>	
<b>WB MODE</b>	<b>MANUAL</b>
R.GAIN	7
B.GAIN	7
SATURATION	7
HUE	7
 SELECT	 BACK

### Available Options:

**WB MODE:** AUTO, ATW (auto tracking), ONE PUSH, INDOOR, OUTDOOR, MANUAL, SODIUM LAMP, FLUO LAMP.

**“ONE PUSH”:** In “ONE PUSH TRIGGER”mode, aim the camera at a pure white object (say a white paper), then press + button.

**“AUTO” mode:** R.GAIN, G.GAIN and B.Gain can be chosen from -7 ~ +7.



**“MANUAL”mode:** R.GAIN and B. GAIN value can be chosen from 0~255.

**SATURATION:** 0, 1, 2, 3, 4, 5, 6, 7, 8, 9, 10,11, 12, 13, 14.

**HUE:** 0, 1, 2, 3, 4, 5, 6, 7, 8, 9, 10, 11, 12, 13,14.

## Pan/Tilt/Zoom

PAN/TILT/ZOOM is used to change pan/tilt/zoom value, available options:

<PAN TILT ZOOM>	
<b>PAN/TILE SPEED</b>	<b>8</b>
D-ZOOM LIMIT	X1
PTZ TRIG AF	ON
RATIO SPEED	ON
POWER UP ACTION	HOME
 SELECT	 BACK

### Available Options:

**PAN/TILT SPEED:** 1, 2, 3, 4, 5, 6, 7, 8 the bigger the number is, the faster the speed is.



**D-ZOOM LIMIT:** X1, X2, X3, X4, X5, X6, X7, X8, X9, X10, X11, X12.

**PTZ TRIG AF:** Turn ON / OFF the auto focus when the camera pans / tilts / zooms.

**RATIO SPEED (ON, OFF):** Set the relation of PT speed as per zoom time. When it's on, PTZ speed will be faster when zoom time is bigger.

**POWER UP ACTION:** PRESET 1, PRESET 2, PRESET 3, PRESET 4, PRESET 5, PRESET 6, PRESET 7, PRESET 8, PRESET 9, HOME.

## System

<SYSTEM>	
<b>ADDRESS</b>	<b>1</b>
PROTOCOL	VISCA
BAUD RATE	9600
IR ADDRESS	1
VIDEO FORMAT	1080P25
MOUNT MODE	STAND
RS232/485	RS232
LANGUAGE	ENGLISH
 SELECT	 BACK

### Available Options:

**ADDRESS:** 1, 2, 3, 4, 5, 6, 7.

**PROTOCOL:** VISCA, PELCO-D, PELCO-P.

**BAUD RATE:** 2400, 4800, 9600, 38400.

**IR ADDRESS:** 1, 2, 3, 4. set camera address to be controlled by remote controller.

**VIDEO FORMAT:** 1080P60, 1080P50, 1080P30, 1080P25, 1080I60, 1080I50, 720P60, 720P50.

**MOUNT MODE:** STAND,CEILING

**RS232/485:** RS232, RS485

**LANGUAGE:** ENGLISH

---

## Status

Display information (address, protocol, baud rate, IR address, video format, mount mode and firmware version) of the current camera

<STATUS>	
ADDRESS	1
PROTOCOL	VISCA
BAUD RATE	9600
IR ADDRESS	1
VIDEO FORMAT	1080P25
MOUNT MODE	STAND
FIRMWARE VER	V1.0.37
	 BACK

## Restore Defaults

RESTORE DEFAULTS option is used to reset all menus to default value.

<RESTORE DAFUALTS>	
PRESS OK	CONFIRM
PRESS BACK	CANCEL

Press “+” to confirm or press “-” to cancel and return to previous menu.

## List Of Special Preset Commands

Preset No.	Function
0	Full-View
1	Tracking
8	Track the left-bound preset
9	Track the right -bound preset
80	Turn on tracing
81	Turn off tracing
93	Cruise, camera switches among saved 0~29 presets repeatedly and sequentially in fixed interval.
95	Get into menu
96	Delete all presets
99	Reboot the PTZ

## 3.3 Network Connection

### 3.3.1 LAN Connection

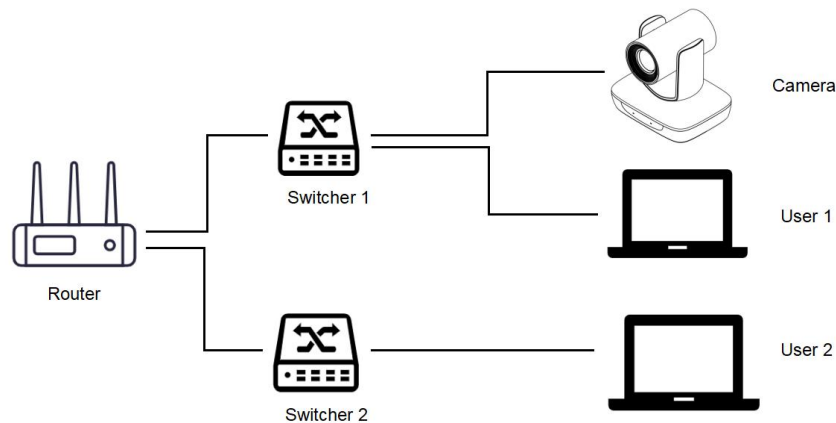

Please refer to the above diagram, user 1 and user 2 are in the same router, they are considered as in the same LAN, connect the camera to the same LAN as where the PC is, and refer to below instructions as how to use the application software, then the camera can be found and connected from the online device list.

### 3.3.2 WAN Connection

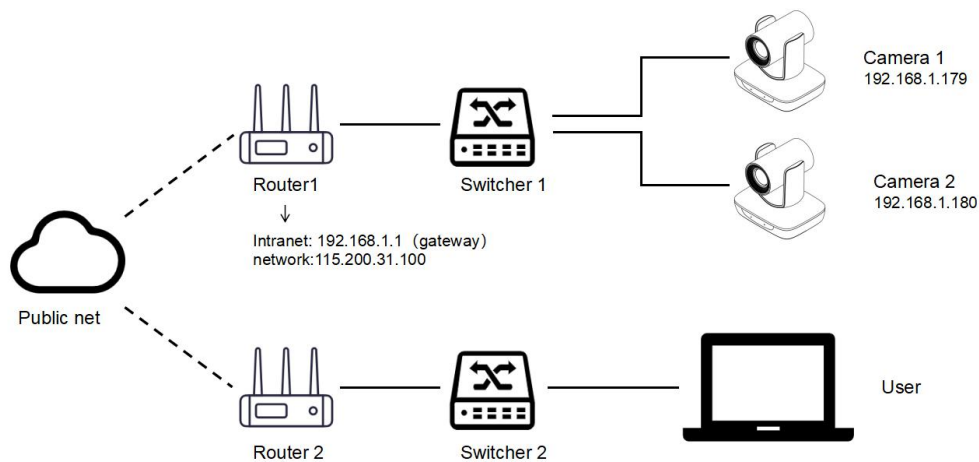

Please refer to the above diagram, user and the camera are in different routers, they are considered as in a WAN; in this condition, application software CameraCMS can not search and find the camera automatically. User can still connect after below conditions are satisfied.

(1) Set camera's IP address as static IP address.

Set camera's IP address in LAN: connect user PC to the LAN (Router 1) where the camera is connected according to LAN connection instructions, use application software CameraCMS to search and find the camera, then add it to manage; then set camera's IP address in the same network segment as the router 1. Camera's gateway is usually set at Router 1's LAN IP address, for example, 192.168.1.1, then camera's IP address can be set as for example 192.168.1.179 or 192.168.1.180 as long as they are in the same network segment.

(2) Router of the LAN where camera is connected supports Port Mapping.

Route Mapping: User PC logs into router configuration menu, gets into "Port Mapping" (router management authorization may be required); refer to below picture, DO NOT tick "Do not apply this rule", from first frame under "External port", input any number from 1~65535, but preferred to be set at more than 10000 like 10200 so there will be less port conflict possibility. From "Internal IP", input the camera's IP address 192.168.1.179, from first frame of "Internal Port", input 3478, (all cameras use this same port number). "Protocol" and "Mapping Line" can be default, from "Note", input "Camera 1's mapping port" or something to understand.

**Port mapping**

**List of rules**

**Do not apply this rule**  
If you disable this rule, the following configuration will only be saved but will not applied.

**External port**  
You can input an external port or an external port segment to be mapped to an open port or port segment of an internal host. If you leave it blank, the external port or port segment is identical to the internal port or port segment. The range is between 1 and 65535.

**Internal IP**  
The IP address of the internal host that provides external service. For example: 192.168.0.50

**Internal port**  
The open port or port segment of the internal host that provides external services. The range is between 1 and 65535.

**Protocol**  
TCP  
The protocol used for port mapping can be TCP, UDP or both.

**Mapping line**  
Any  
The line used for port mapping can be single WAN or multi WAN.

**Note**  
You can write a short note to describe this mapping rule. For example: The WEB server for Marketing Department.

**Save** **Back**

**Help**  
Port mapping function can map the service port of the intranet server host to extranet, so external network users can access the services offered by the intranet server through the external IP address and port of the router.  
**Notice:**  
· Port mapping works only if "Block extranet requests" on the Attack defense page is disabled.

(3) Router of the LAN where camera is connected has fixed public IP address.

Access from external network: Router 1's public IP address is 115.200.31.100, for example, go through the above steps one and two, WAN users under router 2 can access camera 1 through IP address 115.200.31.100 + port 10200. Then, in WAN, the mapping of camera 1 and (IP 115.200.31.100 + port 10200) is established. Camera 2 can use another external port such as 10320, so mapping of camera 2 with (IP 115.200.31.100 + port 10320) is established. In the "Managed Device" of the client software CameraCMS, click "+ Add", enter the IP address 115.200.31.100 and port 10200 and other information, then the camera 1 can be accessed and controlled.

# 3.4 Client Software Instruction

## 3.4.1 Search and List the Camera

**Step 1:** Install and open the client software in PC, enter the main interface:

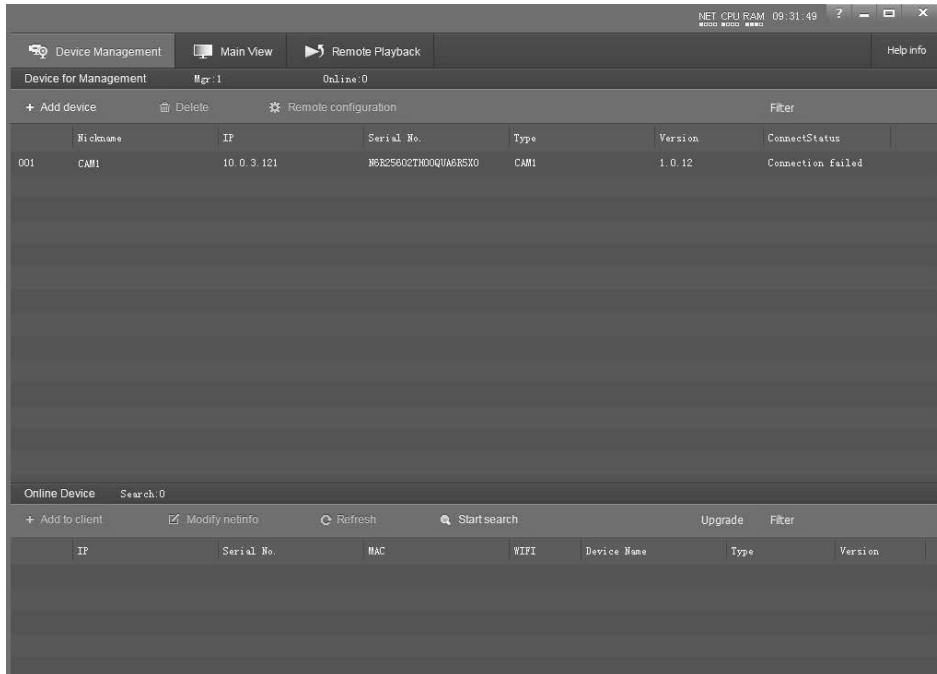

**Step 2:** If the camera and PC are in the same LAN, click “Start Search”, then searching starts and all online devices will be listed, as the picture shown below:

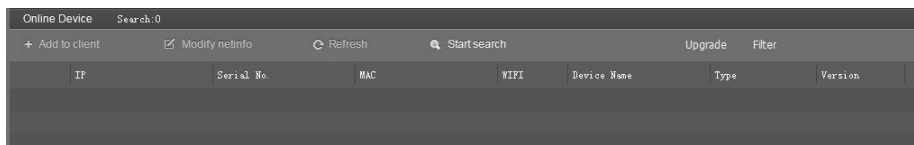

**Step 3:** To modify the device IP address, input the IP address, mask, gateway in the “Modify Network”column.

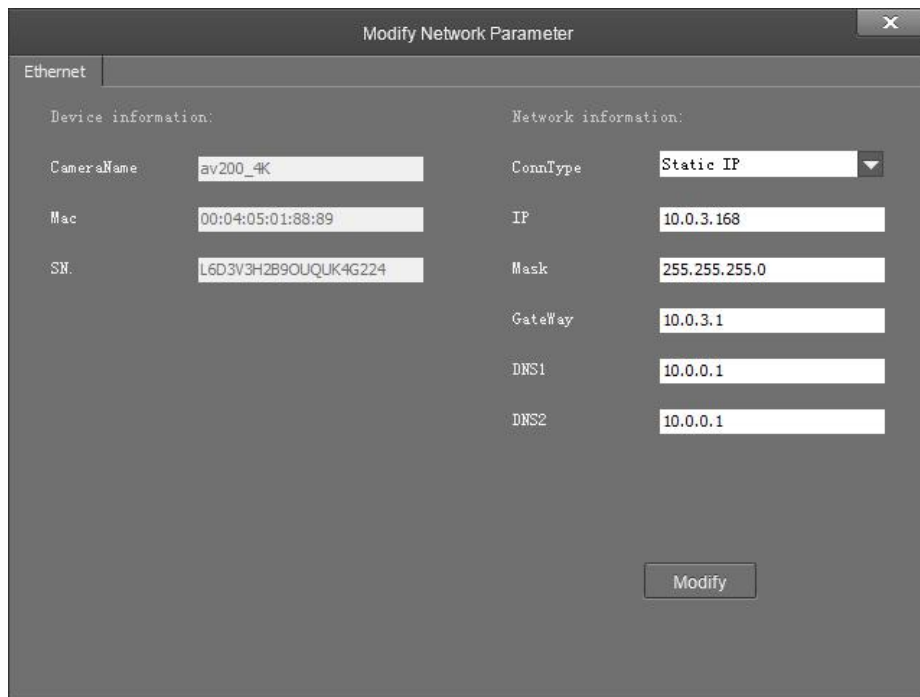

**Step 4:** To control and preview a camera, first choose the device, modify its IP address as the IP address of the same LAN, then click “Add to client ”as the picture shown below.Please check that all IP addresses are in the same LAN.

	IP	Serial No.	MAC	WiFi	Device Name	Type	Version
010	10.0.3.179	X332E102100WQF28035	00:04:05:0F:6A:CD	No	CAM1	CAM1	1.0.12
011	10.0.3.236	R1V5K402U702Q85A424	00:04:05:0F:70:97	No	CAM2	CAM2	1.0.95

### 3.4.2 Preview

Click “Main Menu ”to get into camera control and preview part as below

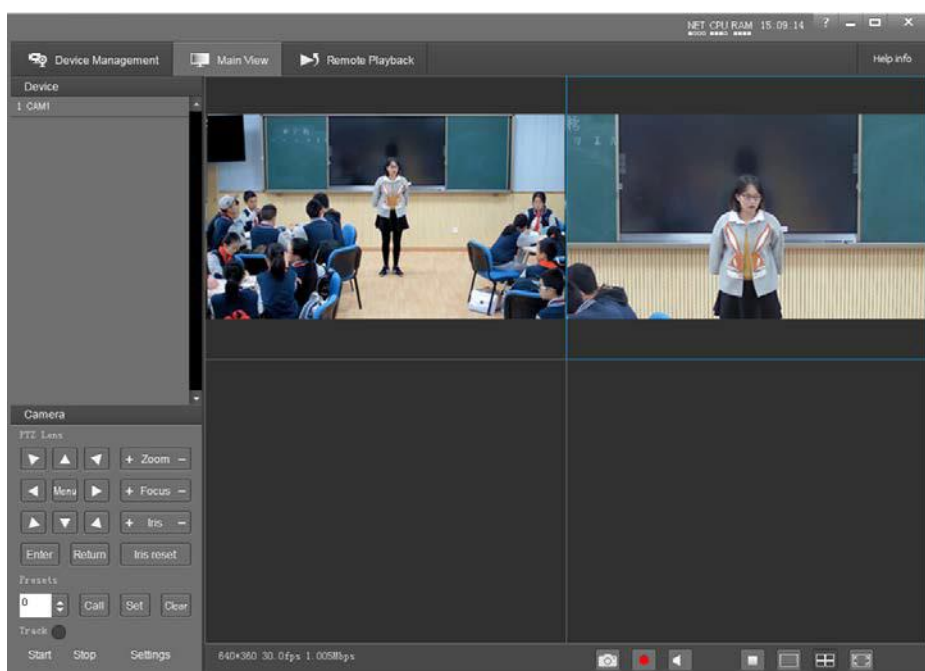



This interface includes three main parts: Device List, Device Control, Video Preview.

- Device: it displays all online cameras added to “Device Management”.
- Device Control: get control of the selected camera (camera name in blue).

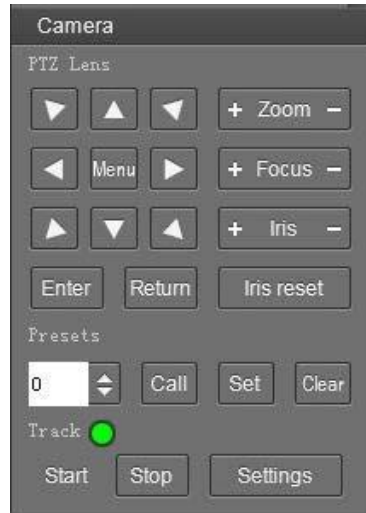

● Video Preview: double click the camera in the list, main camera stream will be displayed in the preview window; or right click the selected camera from the left column to get its main or substream video. Video preview mode can be single video or four video's, when in four video's mode, select one of the four video's then choose the bottom right icon to enlarge this selected video to a big single window.

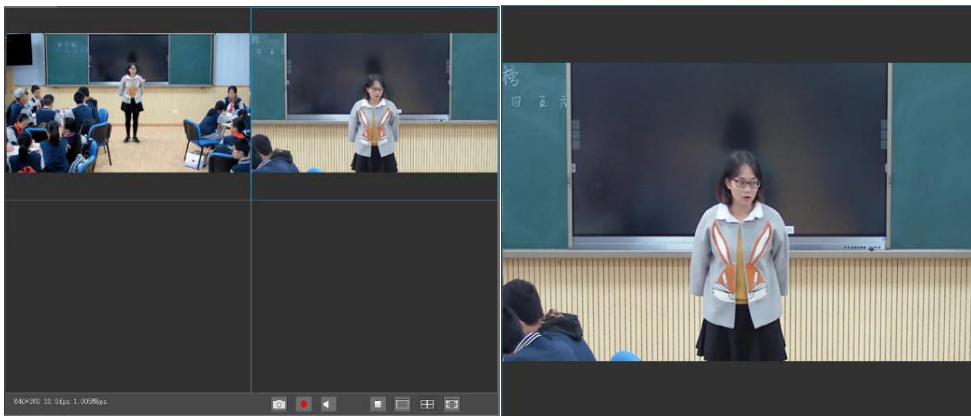

### 3.4.3 Settings

#### Software Connection

If you want to track settings, you can Install and turn on “CameraCMS”, click on [Start Search](#) / [Add to client](#) /

[Main View](#) / [Track](#) / [Settings](#)

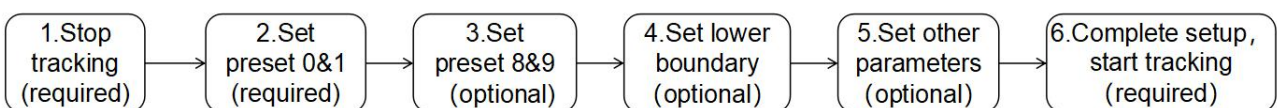

---

## 1. Stop Tracking



**Stop:** turn off tracking, using controller or software to call preset 81 can also turn off tracking.

## 2. Set preset 0 & 1

Preset 1: preset 1 is the position where tracking starts, preferred to be set at Podium, to configure it, move the camera's Pan/Tilt/Zoom to put the lecturer in the appropriate size and position in the image, then set it as preset 1.

Preset 0: it is a position that can be configured to have the camera move to once tracked object gets lost, recommended to set at a full view image of the lecturing area. See basic parameter settings for details.

## 3. Set preset 8 & 9

Tracking left and right limit: if set (not specified : you could set 8 as the limit on the left, 9 as the limit on the right; Or set 8 to the right limit and 9 to the left limit), and the camera horizontal tracking will be between these two preset positions. If the target exceeds the limit, it returns to the 0 position.

If not set (default is not set) the entire process is tracked.

## 4. Set lower boundary, the default line is in the center of the image.



Start tracking the target altitude line:

When the camera is target-free (at bit 0), the detected target head must be higher than the line before camera tracking can be triggered.

In order to avoid untracked targets (such as sitting students) triggering tracking by mistake.

## 5. Set other parameters, default values are recommended.



Tilt Motion: when it's enabled, the camera will automatically adjust tilt angle during tracking. When it's disabled, the camera will track as per the tilt angle of preset 1.

If the lecturer does not walk into the student area, it's suggested to disable auto zoom and tilt motion.

## Tracking Parameters

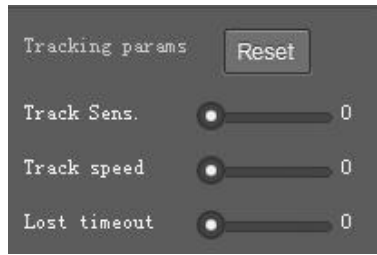

Track Sens: set sensitivity of tracking based on speed of movement. High sensitivity will track at small movement.

Track Speed: set pan speed for tracking;

Lost Timeout: set the interval before Object lost action will be performed, (go to preset 1 or 0). Default is 5 seconds.

### Power On State



Power On State: the action to be performed when the camera is powered on.

## 6. Complete setup, start tracking

Start: turn on tracking, using controller or software to call preset 80 can also turn on tracking.

Settings: click this button to get into detailed tracking parameters for configuration.

---

# Chapter 4 Ordering Codes

---

## 4.1 Product

981-0011-21-0

RGB20X-NAI-GY Educational Tracking Camera

# Chapter 5 Support

## 5.1 Contact us

www.rgblink.com



### Inquiries

+86-592-577-1197

info@rgblink.com

rgblink.com/contact-us

### Global Support

support@rgblink.com

rgblink.com/support-me



@RGLINK



/rgblink



+rgblink



/rgblink



rgblink



rgblink

<b>RGBlink Headquarters</b> Xiamen, China  6 <sup>th</sup> Floor Weiye Building Torch Park Hi Tech Zone Huli  ✉ sales@rgblink.com ☎ +86-592-577-1197	<b>China Regional Sales &amp; Support</b> Shenzhen, China  11 <sup>th</sup> Floor Baiwang Building 5318 Shahe West Road Baimang, Nanshan  ☎ +86-755-2153-5149	<b>Beijing Region Office</b> Beijing, China  Building 8, 25 Qixiao Road Shahe Town Changping  ☎ +86- 4008-592-114	<b>Europe Regional Sales &amp; Support</b> Eindhoven, Holland  Flight Forum Eindhoven 5657 DW  ✉ eu@rgblink.com ☎ +31(040)-202-71-83	<b>India Regional Sales &amp; Support</b> Mumbai, India  78/626, Motilal Nagar, No1, Rd No1, Goregaon West, Mumbai  ✉ support@rgblink.com ☎ +91-98200-86718
--	--	---	---	---

## 5.2 Trouble Shooting

Problem	Possible Cause	Solution
No action or image after powered on	Power supply failure	Check power supply
	Power adapter damaged	Replace power adapter
	Power cable connection got loosen	Check & reconnect
No self-testing after powered on, or with motor noise	Power cable is too long	Use a shorter cable
	Power adapter damaged	Replace power adapter
	Mechanical failure	Repair
Not controllable from remote controller	Low battery of remote controller	Change battery for remote controller
	Exceed remote control distance	Control within distance of 8M
After power on, self-test successfully, but not controllable	Wrong address / protocol / baud rate	Check & set again
	Wrong connection or open circuit of RS-485 or RS-232 cable	Check & reconnect
Video loss when pans / tilts / zooms	Power cable is too long	Use a shorter cable
	Power adapter damaged	Replace power adapter
	Video cable not properly connected	Replace with a good video cable
Video captured after connected to digital video interface of a capture device is not good as the video captured after connected directly analog video interface of the capture device	Different video capture devices have different video capturing performance, image quality maybe worse after it has been converted from analog to digital	Consult video capture device supplier for more information

# Chapter 6 Appendix

## 6.1 Specification

Items	Value
Image Sensor	1/2.8" CMOS, 2.14 megapixel
Focal Lens	f=4.7~94.0mm
Optical Zoom	20x
Digital Zoom	12x
Iris	F1.6~F3.5
Horizontal Viewing Angle	59.5° - 2.9°
Focus System	Auto, Manual, PTZ Trigger, One Push Trigger
Shutter Speed	1/1s to 1/10,000s
Gain	Auto, Manual
White Balance	Auto, Indoor, Outdoor, One Push, Manual, Auto Tracking
Exposure Control	Auto, Manual, Shutter Priority, Iris Priority
S/N	≥55dB
Menu	English
<b>PTZ</b>	
Pan Angle	-170°~+170°
Tilt Angle	-30°~+90°
Pan Speed	0.2°/S~100°/S
Tilt Speed	0.2°/S~60°/S
Preset Number	64
<b>Video Output</b>	
Video Format	1080P60, 1080P50, 1080P30, 1080P25, 1080I60, 1080I50, 720P60, 720P50
<b>NETWORK</b>	
Resolution	Max 1920*1080P60
Image Compression	H.265, H.264

Audio Compression	AAC
Protocols	ONVIF, RTSP, RTMP, HTTP, TCP, UDP
Dual Stream	Support
<b>USB</b>	
USB Interface	USB3.0 Type-B
UVC, UAC	Support
Video Interface	H.264 / MJPEG
Image Size	1920x1080, 1280x720, 640x360
<b>Interface</b>	
Video Interface	HDMI 1.4 / 3G-SDI
Network Interface	RJ45 (100M) interface, Reserved power over Ethernet
Control Interface	RS-485 / RS-232
<b>General</b>	
Protocols	VISCA, PELCO-D
Address	0~63
Power	DC12V
Power Consumption	<15W
Operating Temperature	0°C~+40°C
Storage Temperature	-20°C~+60°C
Operating Humidity	10% RH~ 90% RH
Dimensions (W×H×D)	176mm×169mm×136mm
Weight	<1.1KG
Body color	grey

## 6.2 VISCA Protocol List

### 6.2.1 Camera Return Command

Ack/Completion Message		
	Command packet	Note
ACK	z0 41 FF	Returned when the command is accepted.
Completion	z0 51 FF	Returned when the command has been executed.

z = camera address + 8

Error Messages		
	Command packet	Note
Syntax Error	z0 60 02 FF	Returned when the command format is different or when a command with illegal command parameters is accepted
Command Not Executable	z0 61 41 FF	Returned when a command cannot be executed due to current conditions. For example, when commands controlling the focus manually are received during auto



		focus.
--	--	--------

## 6.2.2 Camera Control Command

Command	Function	Command packet	Note
AddressSet	Broadcast	88 30 0p FF	p: Address setting
IF_Clear	Broadcast	88 01 00 01 FF	I/F Clear
CommandCancel		8x 21 FF	
CAM_Power	On	8x 01 04 00 02 FF	Power ON/OFF
	Off	8x 01 04 00 03 FF	
CAM_Zoom	Stop	8x 01 04 07 00 FF	p = 0(low) - F(high) pqrs: Zoom Position
	Tele(Standard)	8x 01 04 07 02 FF	
	Wide(Standard)	8x 01 04 07 03 FF	
	Tele(Variable)	8x 01 04 07 2p FF	
	Wide(Variable)	8x 01 04 07 3p FF	
	Direct	8x 01 04 47 0p 0q 0r 0s FF	
CAM_Focus	Stop	8x 01 04 08 00 FF	p = 0(low) - F(high) pqrs: Focus Position
	Far(Standard)	8x 01 04 08 02 FF	
	Near(Standard)	8x 01 04 08 03 FF	
	Far(Variable)	8x 01 04 08 2p FF	
	Near (Variable)	8x 01 04 08 3p FF	
	Direct	8x 01 04 48 0p 0q 0r 0s FF	
	Auto Focus	8x 01 04 38 02 FF	
	Manual Focus	8x 01 04 38 03 FF	
CAM_Zoom Focus	Direct	8x 01 04 47 0p 0q 0r 0s 0t 0u 0v 0w FF	pqrs: Zoom Position tuvw: Focus Position
CAM_WB	Auto	8x 01 04 35 00 FF	
	3000K	8x 01 04 35 01 FF	
	4000k	8x 01 04 35 02 FF	
	One Push mode	8x 01 04 35 03 FF	
	5000k	8x 01 04 35 04 FF	
	Manual	8x 01 04 35 05 FF	
	6500k	8x 01 04 35 06 FF	
CAM_RGain	Reset	8x 01 04 03 00 FF	Manual Control of R Gain
	Up	8x 01 04 03 02 FF	
	Down	8x 01 04 03 03 FF	
	Direct	8x 01 04 43 00 00 0p 0q FF	pq: R Gain
CAM_Bgain	Reset	8x 01 04 04 00 FF	Manual Control of B Gain
	Up	8x 01 04 04 02 FF	
	Down	8x 01 04 04 03 FF	
	Direct	8x 01 04 44 00 00 0p 0q FF	pq: B Gain
CAM_AE	Full Auto	8x 01 04 39 00 FF	Automatic Exposure mode
	Manual	8x 01 04 39 03 FF	Manual Control mode
	Shutter priority	8x 01 04 39 0A FF	Shutter Priority Automatic Exposure mode
	Iris priority	8x 01 04 39 0B FF	Iris Priority Automatic Exposure mode
	Bright	8x 01 04 39 0D FF	Bright mode

Command	Function	Command packet	Note
CAM_Shutter	Reset	8x 01 04 0A 00 FF	Shutter Setting
	Up	8x 01 04 0A 02 FF	
	Down	8x 01 04 0A 03 FF	
	Direct	8x 01 04 4A 00 00 0p 0q FF	pq: Shutter Position
CAM_Iris	Reset	8x 01 04 0B 00 FF	Iris Setting
	Up	8x 01 04 0B 02 FF	
	Down	8x 01 04 0B 03 FF	
	Direct	8x 01 04 4B 00 00 0p 0q FF	pq: Iris Position
CAM_Gain Limit	Gain Limit	8x 01 04 2C 0p FF	p: Gain Positon
CAM_Bright	Reset	8x 01 04 0D 00 FF	Bright Setting
	Up	8x 01 04 0D 02 FF	
	Down	8x 01 04 0D 03 FF	
	Direct	8x 01 04 4D 00 00 0p 0q FF	pq: Bright Positon
CAM_ExpComp	On	8x 01 04 3E 02 FF	Exposure Compensation ON/OFF
	Off	8x 01 04 3E 03 FF	
	Reset	8x 01 04 0E 00 FF	Exposure Compensation Amount Setting
	Up	8x 01 04 0E 02 FF	
	Down	8x 01 04 0E 03 FF	
	Direct	8x 01 04 4E 00 00 0p 0q FF	pq: ExpComp Position
CAM_Back Light	On	8x 01 04 33 02 FF	Back Light Compensation
	Off	8x 01 04 33 03 FF	
CAM_WDRStrength	Reset	8x 01 04 21 00 FF	WDR Level Setting
	Up	8x 01 04 21 02 FF	
	Down	8x 01 04 21 03 FF	
	Direct	8x 01 04 51 00 00 0p FF	p: WDR Level Positon
CAM_NR (2D)		8x 01 04 53 0p FF	P=0-7 0:OFF
CAM_NR (3D)		8x 01 04 54 0p FF	P=0-8 0:OFF
CAM_Gamma		8x 01 04 5B 0p FF	p = 0 – 4 0: Default 1: 0.45 2: 0.50 3: 0.55 4: 0.63
CAM_Flicker	OFF	8x 01 04 23 00 FF	OFF
	50HZ	8x 01 04 23 01 FF	50HZ
	60HZ	8x 01 04 23 02 FF	60HZ
CAM_Aperture	Reset	8x 01 04 02 00 FF	Aperture Control
	Up	8x 01 04 02 02 FF	
	Down	8x 01 04 02 03 FF	
	Direct	8x 01 04 42 00 00 0p 0q FF	pq: Aperture Gain
CAM_Memory	Reset	8x 01 04 3F 00 pq FF	pq: Memory Number(=0 to 254) Corresponds to 0 to 9 on the Remote Commander
	Set	8x 01 04 3F 01 pq FF	
	Recall	8x 01 04 3F 02 pq FF	
CAM_LR_Reverse	On	8x 01 04 61 02 FF	Image Flip Horizontal ON/OFF
	Off	8x 01 04 61 03 FF	
CAM_PictureFlip	On	8x 01 04 66 02 FF	Image Flip Vertical ON/OFF
	Off	8x 01 04 66 03 FF	
CAM_ColorSaturation	Direct	8x 01 04 49 00 00 00 0p FF	P=0-E 0:60% 1:70% 2:80% 3:90% 4:100% 5:110% 6:120% 7:130% 8:140% 9:150% 10:160% 11:160% 12:180%

Command	Function	Command packet	Note
			13:190% 14:200%
CAM_IDWrite		8x 01 04 22 0p 0q 0r 0s FF	pqrs: Camera ID (=0000 to FFFF)
SYS_Menu	ON	8x 01 04 06 06 02 FF	Turn on the menu screen
	OFF	8x 01 04 06 06 03 FF	Turn off the menu screen
IR_Receive	ON	8x 01 06 08 02 FF	IR(remote commander)receive On/Off
	OFF	8x 01 06 08 03 FF	
IR_ReceiveReturn	On	8x 01 7D 01 03 00 00 FF	IR(remote commander)receive message via the VISCA communication ON/OFF
	Off	8x 01 7D 01 13 00 00 FF	
CAM_SettingReset	Reset	8x 01 04 A0 10 FF	Reset Factory Setting
CAM_Brightness	Direct	8x 01 04 A1 00 00 0p 0q FF	pq: Brightness Position
CAM_Contrast	Direct	8x 01 04 A2 00 00 0p 0q FF	pq: Contrast Position
CAM_Flip	OFF	8x 01 04 A4 00 FF	Single Command For Video Flip
	Flip-H	8x 01 04 A4 01 FF	
	Flip-V	8x 01 04 A4 02 FF	
	Flip-HV	8x 01 04 A4 03 FF	
CAM_VideoSystem	Set camera video system	8x 01 06 35 00 0p FF	P: 0~E Video format 0:1080P60 8:720P30 1:1080P50 9:720P25 2:1080i60 A: 1080P59.94 3:1080i50 B: 1080i59.94 4:720P60 C: 720P59.94 5:720P50 D: 1080P29.97 6:1080P30 E: 720P29.97 7:1080P25
Pan_tiltDrive	Up	8x 01 06 01 VV WW 03 01 FF	VV: Pan speed 0x01 (low speed) to 0x18 (high speed) WW: Tilt speed 0x01 (low speed) to 0x14 (high speed) YYYY: Pan Position ZZZZ: Tilt Position
	Down	8x 01 06 01 VV WW 03 02 FF	
	Left	8x 01 06 01 VV WW 01 03 FF	
	Right	8x 01 06 01 VV WW 02 03 FF	
	Upleft	8x 01 06 01 VV WW 01 01 FF	
	Upright	8x 01 06 01 VV WW 02 01 FF	
	DownLeft	8x 01 06 01 VV WW 01 02 FF	
	DownRight	8x 01 06 01 VV WW 02 02 FF	
	Stop	8x 01 06 01 VV WW 03 03 FF	
	AbsolutePosition	8x 01 06 02 VV WW 0Y 0Y 0Y 0Y 0Z 0Z 0Z 0Z FF	
	RelativePosition	8x 01 06 03 VV WW 0Y 0Y 0Y 0Y 0Z 0Z 0Z 0Z FF	
	Home	8x 01 06 04 FF	
	Reset	8x 01 06 05 FF	
Pan-tiltLimitSet	Set	8x 01 06 07 00 0W 0Y 0Y 0Y 0Y 0Z 0Z 0Z 0Z FF	W:1 UpRight 0:DownLeft YYYY: Pan Limit Position(TBD) ZZZZ: Tilt Limit Position(TBD)
	Clear	8x 01 06 07 01 0W 07 0F 0F 0F 07 0F 0F 0F FF	

## 6.2.3 Inquiry Command

Command	Function	Command packet	Note
CAM_PowerInq	8x 09 04 00 FF	y0 50 02 FF	On
		y0 50 03 FF	Off(Standby)
CAM_ZoomPosInq	8x 09 04 47 FF	y0 50 0p 0q 0r 0s FF	pqrs: Zoom Position
CAM_FocusAFModelInq	8x 09 04 38 FF	y0 50 02 FF	Auto Focus
		y0 50 03 FF	Manual Focus
CAM_FocusPosInq	8x 09 04 48 FF	y0 50 0p 0q 0r 0s FF	pqrs: Focus Position
CAM_WBModelInq	8x 09 04 35 FF	y0 50 00 FF	Auto
		y0 50 01 FF	3000K
		y0 50 02 FF	4000K
		y0 50 03 FF	One Push Mode
		y0 50 04 FF	5000K
		y0 50 05 FF	Manual
		y0 50 00 FF	6500K
CAM_RGainInq	8x 09 04 43 FF	y0 50 00 00 0p 0q FF	pq: R Gain
CAM_BGainInq	8x 09 04 44 FF	y0 50 00 00 0p 0q FF	pq: B Gain
CAM_AEModelInq	8x 09 04 39 FF	y0 50 00 FF	Full Auto
		y0 50 03 FF	Manual
		y0 50 0A FF	Shutter priority
		y0 50 0B FF	Iris priority
		y0 50 0D FF	Bright
CAM_ShutterPosInq	8x 09 04 4A FF	y0 50 00 00 0p 0q FF	pq: Shutter Position
CAM_IrisPosInq	8x 09 04 4B FF	y0 50 00 00 0p 0q FF	pq: Iris Position
CAM_Gain LimitInq	8x 09 04 2C FF	y0 50 0p FF	p: Gain Positon
CAM_BrightPosInq	8x 09 04 4D FF	y0 50 00 00 0p 0q FF	pq: Bright Position
CAM_ExpCompModelInq	8x 09 04 3E FF	y0 50 02 FF	On
		y0 50 03 FF	Off
CAM_ExpCompPosInq	8x 09 04 4E FF	y0 50 00 00 0p 0q FF	pq: ExpComp Position
CAM_BacklightModelInq	8x 09 04 33 FF	y0 50 02 FF	On
		y0 50 03 FF	Off
CAM_WDRStrengthInq	8x 09 04 51 FF	y0 50 00 00 00 0p FF	p: WDR Strength
CAM_NRLevel(2D) Inq	8x 09 04 53 FF	y0 50 0p FF	P: 2DNrLevel
CAM_NRLevel(3D) Inq	8x 09 04 54 FF	y0 50 0p FF	P:3D NRLevel
CAM_FlickerModelInq	8x 09 04 55 FF	y0 50 0p FF	p: Flicker Settings(0: OFF, 1: 50Hz, 2:60Hz)
CAM_ApertureInq	8x 09 04 42 FF	y0 50 00 00 0p 0q FF	pq: Aperture Gain
CAM_PictureEffectModelInq	8x 09 04 63 FF	y0 50 00 FF	Off
		y0 50 04 FF	B&W
CAM_MemoryInq	8x 09 04 3F FF	y0 50 0p FF	p: Memory number last operated.
SYS_MenuModelInq	8x 09 06 06 FF	y0 50 02 FF	On
		y0 50 03 FF	Off
CAM_LR_ReverselInq	8x 09 04 61 FF	y0 50 02 FF	On
		y0 50 03 FF	Off
CAM_PictureFlipInq	8x 09 04 66 FF	y0 50 02 FF	On
		y0 50 03 FF	Off
CAM_ColorSaturationInq	8x 09 04 49 FF	y0 50 00 00 00 0p FF	p: Color Gain setting 0h (60%) to Eh (130%)
CAM_IDInq	8x 09 04 22 FF	y0 50 0p FF	p: Gamma ID
IR_ReceiveInq	8x 09 06 08 FF	y0 50 02 FF	On
		y0 50 03 FF	Off

IR_ReceiveReturn		y0 07 7D 01 04 00 FF	Power ON/OFF
		y0 07 7D 01 04 07 FF	Zoom tele/wide
		y0 07 7D 01 04 38 FF	AF ON/OFF
		y0 07 7D 01 04 33 FF	Camera _Backlight
		y0 07 7D 01 04 3F FF	Camera _Memery
		y0 07 7D 01 06 01 FF	Pan_titleDriver
CAM_BrightnessInq	8x 09 04 A1 FF	y0 50 00 00 0p 0q FF	pq: Brightness Position
CAM_ContrastInq	8x 09 04 A2 FF	y0 50 00 00 0p 0q FF	pq: Contrast Position
CAM_FlipInq	8x 09 04 A4 FF	y0 50 00 FF	Off
		y0 50 01 FF	Flip-H
		y0 50 02 FF	Flip-V
		y0 50 03 FF	Flip-HV
CAM_GammaInq	8x 09 04 5B FF	y0 50 0p FF	p: Gamma setting
CAM_VersionInq	8x 09 00 02 FF	y0 50 ab cd mn pq rs tu vw FF	ab cd : vender ID ( 0220 ) mn pq : model ID ST ( 0510 ) 、 U2( 0512 )、 U3 ( 0513 )、 HD ( ? ? ) rs tu : ARM Version vw : reserve
VideoSystemInq	8x 09 06 23 FF	y0 50 0p FF	P: 0~E Video format 0:1080P60 8:720P30 1:1080P50 9:720P25 2:1080i60 A: 1080P59.94 3:1080i50 B: 1080i59.94 4:720P60 C: 720P59.94 5:720P50 D: 1080P29.97 6:1080P30 E: 720P29.97 7:1080P25
Pan-tiltMaxSpeedInq	8x 09 06 11 FF	y0 50 ww zz FF	ww: Pan Max Speed zz: Tilt Max Speed
Pan-tiltPosInq	8x 09 06 12 FF	y0 50 0w 0w 0w 0w 0z 0z 0z 0z FF	www: Pan Position zzzz: Tilt Position

Note:[X] in the above table indicates the camera address to be operated, **[y] = [x + 8]** .

## 6.3 Pelco-D Protocol Command List

Function	Byte1	Byte2	Byte3	Byte4	Byte5	Byte6	Byte7
Up	0xFF	Address	0x00	0x08	Pan Speed	Tilt Speed	SUM
Down	0xFF	Address	0x00	0x10	Pan Speed	Tilt Speed	SUM
Left	0xFF	Address	0x00	0x04	Pan Speed	Tilt Speed	SUM
Right	0xFF	Address	0x00	0x02	Pan Speed	Tilt Speed	SUM
Upleft	0xFF	Address	0x00	0x0C	Pan Speed	Tilt Speed	SUM
Upright	0xFF	Address	0x00	0x0A	Pan Speed	Tilt Speed	SUM
DownLeft	0xFF	Address	0x00	0x14	Pan Speed	Tilt Speed	SUM

DownRight	0xFF	Address	0x00	0x12	Pan Speed	Tilt Speed	SUM
Zoom In	0xFF	Address	0x00	0x20	0x00	0x00	SUM
Zoom Out	0xFF	Address	0x00	0x40	0x00	0x00	SUM
Focus Far	0xFF	Address	0x00	0x80	0x00	0x00	SUM
Focus Near	0xFF	Address	0x01	0x00	0x00	0x00	SUM
Stop	0xFF	Address	0x00	0x00	0x00	0x00	SUM
Set Preset	0xFF	Address	0x00	0x03	0x00	Preset ID	SUM
Clear Preset	0xFF	Address	0x00	0x05	0x00	Preset ID	SUM
Call Preset	0xFF	Address	0x00	0x07	0x00	Preset ID	SUM
Query Pan Position	0xFF	Address	0x00	0x51	0x00	0x00	SUM
Query Pan Position Response	0xFF	Address	0x00	0x59	Value High Byte	Value Low Byte	SUM
Query Tilt Position	0xFF	Address	0x00	0x53	0x00	0x00	SUM
Query Tilt Position Response	0xFF	Address	0x00	0x5B	Value High Byte	Value Low Byte	SUM
Query Zoom Position	0xFF	Address	0x00	0x55	0x00	0x00	SUM
Query Zoom Position Response	0xFF	Address	0x00	0x5D	Value High Byte	Value Low Byte	SUM

## 6.4 Pelco-P Protocol Command List

Function	Byte1	Byte2	Byte3	Byte4	Byte5	Byte6	Byte7	Byte8
Up	0xA0	Address	0x00	0x08	Pan Speed	Tilt Speed	0xAF	XOR
Down	0xA0	Address	0x00	0x10	Pan Speed	Tilt Speed	0xAF	XOR
Left	0xA0	Address	0x00	0x04	Pan Speed	Tilt Speed	0xAF	XOR
Right	0xA0	Address	0x00	0x02	Pan Speed	Tilt Speed	0xAF	XOR
Upleft	0xA0	Address	0x00	0x0C	Pan Speed	Tilt Speed	0xAF	XOR
Upright	0xA0	Address	0x00	0x0A	Pan Speed	Tilt Speed	0xAF	XOR
DownLeft	0xA0	Address	0x00	0x14	Pan Speed	Tilt Speed	0xAF	XOR
DownRight	0xA0	Address	0x00	0x12	Pan Speed	Tilt Speed	0xAF	XOR
Zoom In	0xA0	Address	0x00	0x20	0x00	0x00	0xAF	XOR
Zoom Out	0xA0	Address	0x00	0x40	0x00	0x00	0xAF	XOR
Stop	0xA0	Address	0x00	0x00	0x00	0x00	0xAF	XOR
Focus Far	0xA0	Address	0x01	0x00	0x00	0x00	0xAF	XOR
Focus Near	0xA0	Address	0x02	0x00	0x00	0x00	0xAF	XOR
Set Preset	0xA0	Address	0x00	0x03	0x00	Preset ID	0xAF	XOR
Clear Preset	0xA0	Address	0x00	0x05	0x00	Preset ID	0xAF	XOR
Call Preset	0xA0	Address	0x00	0x07	0x00	Preset ID	0xAF	XOR
Query Pan Position	0xA0	Address	0x00	0x51	0x00	0x00	0xAF	XOR
Query Pan Position Response	0xA0	Address	0x00	0x59	Value High Byte	Value Low Byte	0xAF	XOR
Query Tilt Position	0xA0	Address	0x00	0x53	0x00	0x00	0xAF	XOR
Query Tilt Position Response	0xA0	Address	0x00	0x5B	Value High Byte	Value Low Byte	0xAF	XOR
Query Zoom Position	0xA0	Address	0x00	0x55	0x00	0x00	0xAF	XOR

Query Zoom Position Response	0xA0	Address	0x00	0x5D	Value High Byte	Value Low Byte	0xAF	XOR
---------------------------------	------	---------	------	------	-----------------	-------------------	------	-----

## 6.5 Terms & Definitions

- **RCA:** Connector used primarily in consumer AV equipment for both audio and video. The RCA connector was developed by the Radio Corporation of America.
- **BNC:** Stands for Bayonet Neill-Concelman. A cable connector used extensively in television (named for its inventors). A cylindrical bayonet connector that operates with a twist-locking motion .
- **CVBS:** CVBS or Composite video, is an analog video signal without audio. Most commonly CVBS is used for transmission of standard definition signals. In consumer applications the connector is typically RCA type, while in professional applications the connector is BNC type.
- **YPbPr:** Used to describe the colour space for progressive-scan. Otherwise known as component video.
- **VGA:** Video Graphics Array. VGA is an analog signal typically used on earlier computers. The signal is non-interlaced in modes 1, 2, and 3 and interlaced when using in mode
- **DVI:** Digital Visual Interface. The digital video connectivity standard that was developed by DDWG (Digital Display Work Group). This connection standard offers two different connectors: one with 24 pins that handles digital video signals only, and one with 29 pins that handles both digital and analog video.
- **SDI:** Serial Digital Interface. Standard definition video is carried on this 270 Mbps data transfer rate. Video pixels are characterized with a 10-bit depth and 4:2:2 color quantization. Ancillary data is included on this interface and typically includes audio or other metadata. Up to sixteen audio channels can be transmitted. Audio is organised into blocks of 4 stereo pairs. Connector is BNC.
- **HD-SDI:** high-definition serial digital interface (HD-SDI), is standardized in SMPTE 292M this provides a nominal data rate of 1.485 Gbit/s.
- **3G-SDI:** standardized in SMPTE 424M, consists of a single 2.970 Gbit/s serial link that allows replacing dual link HD-SDI.
- **6G-SDI:** standardized in SMPTE ST-2081 released in 2015, 6Gbit/s bitrate and able to support 2160p@30.
- **12G-SDI:** standardized in SMPTE ST-2082 released in 2015, 12Gbit/s bitrate and able to support 2160p@60.
- **U-SDI:** Technology for transmitting large-volume 8K signals over a single cable. a signal interface called the ultra high definition signal/data interface (U-SDI) for transmitting 4K and 8K signals using a single optical cable. The interface was standardized as the SMPTE ST 2036-4.
- **HDMI:** High Definition Multimedia Interface: An interface used for the transmission of uncompressed high definition video, up to 8 channels of audio, and control signals, over a single cable.
- **HDMI 1.3:** released on June 22 2006, and increased the maximum TMDS clock to 340 MHz (10.2 Gbit/s). Support resolution 1920 × 1080 at 120 Hz or 2560 × 1440 at 60 Hz). It added support for 10 bpc, 12 bpc, and 16 bpc color depth (30, 36, and 48 bit/px), called deep color.
- **HDMI 1.4 :** released on June 5, 2009, added support for 4096 × 2160 at 24 Hz, 3840 × 2160 at 24, 25, and 30 Hz, and

---

1920 × 1080 at 120 Hz. Compared to HDMI 1.3, 3 more features added which are HDMI Ethernet Channel (HEC) , audio return channel (ARC),3D Over HDMI, a new Micro HDMI Connector, an expanded set of color spaces.

- **HDMI 2.0:** released on September 4, 2013 increases the maximum bandwidth to 18.0 Gbit/s. Other features of HDMI 2.0 include up to 32 audio channels, up to 1536 kHz audio sample frequency, the HE-AAC and DRA audio standards, improved 3D capability, and additional CEC functions.

- **HDMI 2.0a:** was released on April 8, 2015, and added support for High Dynamic Range (HDR) video with static metadata.

- **HDMI 2.0b:** was released March, 2016, support for HDR Video transport and extends the static metadata signaling to include Hybrid Log-Gamma (HLG).

- **HDMI 2.1 :** released on November 28, 2017. It adds support for higher resolutions and higher refresh rates, Dynamic HDR including 4K 120 Hz and 8K 120 Hz.

- **DisplayPort:** A VESA standard interface primarily for video, but also for audio, USB and other data. DisplayPort (orDP) is backwards compatible with HDMI, DVI and VGA.

- **DP 1.1:** was ratified on 2 April 2007, and version 1.1a was ratified on 11 January 2008. DisplayPort 1.1 allow a maximum bandwidth of 10.8 Gbit/s (8.64 Gbit/s data rate) over a standard 4-lane main link, enough to support 1920x1080@60Hz

- **DP 1.2:** introduced on 7 January 2010, effective bandwidth to 17.28 Gbit/s support increased resolutions, higher refresh rates, and greater color depth, maximum resolution 3840 × 2160@60Hz

- **DP 1.4:** publish on 1 Mar, 2016.overall transmission bandwidth 32.4 Gbit/s ,DisplayPort 1.4 adds support for Display Stream Compression 1.2 (DSC), DSC is a "visually lossless" encoding technique with up to a 3:1 compression ratio. Using DSC with HBR3 transmission rates, DisplayPort 1.4 can support 8K UHD (7680 × 4320) at 60 Hz or 4K UHD (3840 × 2160) at 120 Hz with 30 bit/px RGB color and HDR. 4K at 60 Hz 30 bit/pix RGB/HDR can be achieved without the need for DSC.

- **Multi-mode Fiber:** Fibers that support many propagation paths or transverse modes are called multi-mode fibers, generally have a wider core diameter and are used for short-distance communication links and for applications where high power must be transmitted.

- **Single-mode Fiber:** Fiber that support a single mode are called single-mode fibers. Single-mode fibers are used for most communication links longer than 1,000 meters (3,300 ft).

- **SFP:** small form-factor pluggable , is a compact, hot-pluggable network interface module used for both telecommunication and data communications applications.

- **optical fiber connector:** terminates the end of an optical fiber, and enables quicker connection and disconnection than splicing. The connectors mechanically couple and align the cores of fibers so light can pass. 4 most common types of optical fiber connectors are SC, FC, LC,ST.

- **SC:** (Subscriber Connector), also known as the square connector was also created by the Japanese company – Nippon Telegraph and Telephone. SC is a push-pull coupling type of connector and has a 2.5mm diameter. Nowadays, it is used mostly in single mode fiber optic patch cords, analog, GBIC, and CATV. SC is one of the most popular options, as its simplicity in design comes along with great durability and affordable prices.











- **LC:** (Lucent Connector) is a small factor connector (uses only a 1.25mm ferrule diameter) that has a snap coupling



mechanism. Because of its small dimensions, it is the perfect fit for high-density connections, XFP, SFP, and SFP+ transceivers.

- **FC** :(Ferrule Connector) is a screw type connector with a 2.5mm ferrule. FC is a round shaped threaded fiber optic connector,mostly used on Datacom, telecom, measurement equipment, single-mode laser.
- **ST**: (Straight Tip) was invented by AT&T and uses a bayonet mount along with a long spring-loaded ferrule to support the fiber.
- **USB**: Universal Serial Bus is a standard that was developed in the mid-1990s that defines cables, connectors and communication protocols. This technology is designed to allow a connection, communication and power supply for peripheral devices and computers.
- **USB 1.1**: Full-Bandwidth USB, specification was the first release to be widely adopted by the consumer market. This specification allowed for a maximum bandwidth of 12Mbps.
- **USB 2.0**:or Hi-Speed USB, specification made many improvements over USB 1.1. The main improvement was an increase in bandwidth to a maximum of 480Mbps.
- **USB 3.2**: Super Speed USB with 3 varieties of 3.2 Gen 1(original name USB 3.0), 3.2Gen 2(original name USB 3.1), 3.2 Gen 2x2 (original name USB 3.2) with speed up to 5Gbps,10Gbps,20Gbps respectively.

USB version and connectors figure:

	Type A	Type B	Mini A	Mini B	Micro -A	Micro-B	Type C
USB 2.0							
USB 3.0							
USB 3.1 & 3.2							

- **NTSC** : The colour video standard used in North America and some other parts of the world created by the National Television Standards Committee in the 1950s. NTSC utilizes an interlaced video signals.
- **PAL**: Phase Alternate Line. A television standard in which the phase of the colour carrier is alternated from line to line. It takes four full images (8 fields) for the colour-to-horizontal images (8 fields) for the colour-to-horizontal phase relationship to return to the reference point. This alternation helps cancel out phase errors. For this reason, the hue control is not needed on a PAL TV set. PAL, is widely used in needed on a PAL TV set. PAL, is widely used in Western Europe, Australia, Africa, the Middle East, and Micronesia. PAL uses 625-line, 50-field (25 fps) composite colour transmission system.
- **SMPTE**: Society of Motion image and Television Engineers. A global organization, based in the United States, that sets

---

standards for baseband visual communications. This includes film as well as video and television standards.

- **VESA:** Video Electronics Standards Association. An organization facilitating computer graphics through standards.
- **HDCP:** High-bandwidth Digital Content Protection (HDCP) was developed by Intel Corporation and is in wide use for protection of video during transmission between devices.
- **HDBaseT:** A video standard for the transmission of uncompressed video (HDMI signals) and related features using Cat 5e/Cat6 cabling infrastructure.
- **ST2110:** A SMPTE developed standard, ST2110 describes how to send digital video over and IP networks. Video is transmitted uncompressed with audio and other data in a separate streams.

SMPTE2110 is intended principally for broadcast production and distribution facilities where quality and flexibility are more important.

● **SDVoE:** Software Defined Video over Ethernet (SDVoE) is a method for transmission, distribution and management AV signals using a TCP/IP Ethernet infrastructure for transport with low latency. SDVoE is commonly used in integration applications.

● **Dante AV:** The Dante protocol was developed for and widely adopted in audio systems for the transmission of uncompressed digital audio on IP based networks. The more recent Dante AV specification includes support for digital video.

● **NDI:** Network Device interface (NDI) is a software standard developed by NewTek to enable video-compatible products to communicate, deliver, and receive broadcast quality video in a high quality, low latency manner that is frame-accurate and suitable for switching in a live production environment over TCP (UDP) Ethernet based networks. NDI is commonly found in broadcast applications.

● **RTMP:** Real-Time Messaging Protocol (RTMP) was initially a proprietary protocol developed by Macromedia (now Adobe) for streaming audio, video and data over the Internet, between a Flash player and a server.

● **RTSP :** The Real Time Streaming Protocol (RTSP) is a network control protocol designed for use in entertainment and communications systems to control streaming media servers. The protocol is used for establishing and controlling media sessions between end points.

● **MPEG:** Moving Picture Experts Group is a working group formed from ISO and IEC developing standards that allow audio/video digital compression and Transmission.

● **H.264:** Also known as AVC (Advanced Video Coding) or MPEG-4i is a common video compression standard. H.264 was standardized by the ITU-T Video Coding Experts Group (VCEG) together with the ISO/IEC JTC1 Moving Picture Experts Group (MPEG).

● **H.265:** Also known as HEVC (High Efficiency Video Coding ) H.265 is the successor to the widely used H.264/AVC digital video coding standard. Developed under the auspices of ITU, resolutions up to 8192x4320 may be compressed.

● **API:** An Application Programming Interface (API) provides a predefined function which allows access capabilities and features or routines via a software or hardware, without accessing source code or understanding the details of inner working mechanism. An API call may execute a function and/or provide data feedback/report.

---

●**DMX512:** The communication standard developed by USITT for entertainment and digital lighting systems. The wide adoption of the Digital Multiplex (DMX) protocol has seen the protocol used for a wide range of other devices including video controllers. DMX512 is delivered over cable of 2 twisted pairs with 5pin XLR cables for connection.

●**ArtNet:** An ethernet protocol based on TCP/IP protocol stack, mainly used in entertainment/events applications. Built on the DMX512 data format, ArtNet enables multiple “universes” of DMX512 to be transmitted using ethernet networks for transport.

●**MIDI:** MIDI is the abbreviation of Musical Instrument Digital Interface. As the name indicates the protocol was developed for communication between electronic musical instruments and latterly computers. MIDI instructions are triggers or commands sent over twisted pair cables, typically using 5pin DIN connectors.

●**OSC:** The principle of Open Sound Control (OSC) protocol is for networking sound synthesizers, computers, and multimedia devices for musical performance or show control. As with XML and JSON, the OSC protocol allows sharing data. OSC is transported via UDP packets between devices connected on an Ethernet.

●**Brightness:** Usually refers to the amount or intensity of video light produced on a screen without regard to colour. Sometimes called black level.

●**Contrast Ratio:** The ratio of the high light output level divided by the low light output level. In theory, the contrast ratio of the television system should be at least 100:1, if not 300:1. In reality, there are several limitations. Well-controlled viewing conditions should yield a practical contrast ratio of 30:1 to 50:1.

●**Colour Temperature:** The colour quality, expressed in degrees Kelvin (K), of a light source. The higher the colour temperature, the bluer the light. The lower the temperature, the redder the light. Benchmark colour temperature for the A/V industry include 5000°K, 6500°K, and 9000°K.

●**Saturation:** Chroma, Chroma gain. The intensity of the colour, or the extent to which a given colour in any image is free from white. The less white in a colour, the truer the colour or the greater its saturation. Saturation is the amount of pigment in a colour, and not the intensity.

●**Gamma:** The light output of a CRT is not linear with respect to the voltage input. The difference between what you should have and what is actually output is known as gamma.

●**Frame:** In interlaced video, a frame is one complete image. A video frame is made up of two fields, or two sets of interlaced lines. In a film, a frame is one still image of a series that makes up a motion image.

●**Genlock:** Allows synchronisation of otherwise video devices. A signal generator provides a signal pulses which connected devices can reference. Also see Black Burst and Color Burst.

●**Blackburst:** The video waveform without the video elements. It includes the vertical sync, horizontal sync, and the Chroma burst information. Blackburst is used to synchronize video equipment to align the video output.

●**Colour Burst:** In colour TV systems, a burst of subcarrier frequency located on the back part of the composite video signal. This serves as a colour synchronizing signal to establish a frequency and phase reference for the Chroma signal. Colour burst is 3.58 MHz for NTSC and 4.43 MHz for PAL.

●**Colour Bars:** A standard test pattern of several basic colours (white, yellow, cyan, green, magenta, red, blue, and black) as a reference for system alignment and testing. In NTSC video, the most commonly used colour bars are the SMPTE standard colour bars. In PAL video, the most commonly used colour bars are eight full field bars. On computer monitors the most commonly used colour bars are two rows of reversed colour bars

---

●**Seamless Switching:** A feature found on many video switchers. This feature causes the switcher to wait until the vertical interval to switch. This avoids a glitch (temporary scrambling) which often is seen when switching between sources.

●**Scaling:** A conversion of a video or computer graphic signal from a starting resolution to a new resolution. Scaling from one resolution to another is typically done to optimize the signal for input to an image processor, transmission path or to improve its quality when presented on a particular display.

●**PIP:** Picture-In-Picture. A small image within a larger image created by scaling down one of image to make it smaller. Other forms of PIP displays include Picture-By-Picture (PBP) and Picture- With-Picture (PWP), which are commonly used with 16:9 aspect display devices. PBP and PWP image formats require a separate scaler for each video window .

●**HDR:** is a high dynamic range (HDR) technique used in imaging and photography to reproduce a greater dynamic range of luminosity than what is possible with standard digital imaging or photographic techniques. The aim is to present a similar range of luminance to that experienced through the human visual system.

●**UHD:** Standing for Ultra High Definition and comprising 4K and 8K television standards with a 16:9 ratio, UHD follows the 2K HDTV standard. A UHD 4K display has a physical resolution of 3840x2160 which is four times the area and twice both the width and height of a HDTV/FullHD (1920 x1080) video signal.

●**EDID:** Extended Display Identification Data. EDID is a data structure used to communicate video display information, including native resolution and vertical interval refresh rate requirements, to a source device. The source device will then output the provided EDID data, ensuring proper video image quality.

## 6.6 Revision History

The table below lists the changes to the camera User Manual.

Format	Time	ECO#	Description	Principle
V1.0	2021-12-01	0000#	Release	Sylvia

All information herein is © Xiamen RGBlink Science & Technology Co Ltd. excepting where noted.

RGBlink® is a registered trademark of Xiamen RGBlink Science & Technology Co Ltd. While all efforts are made for accuracy at time of printing, we reserve the right to alter, vary or otherwise make change without notice. E& OM excepted.