

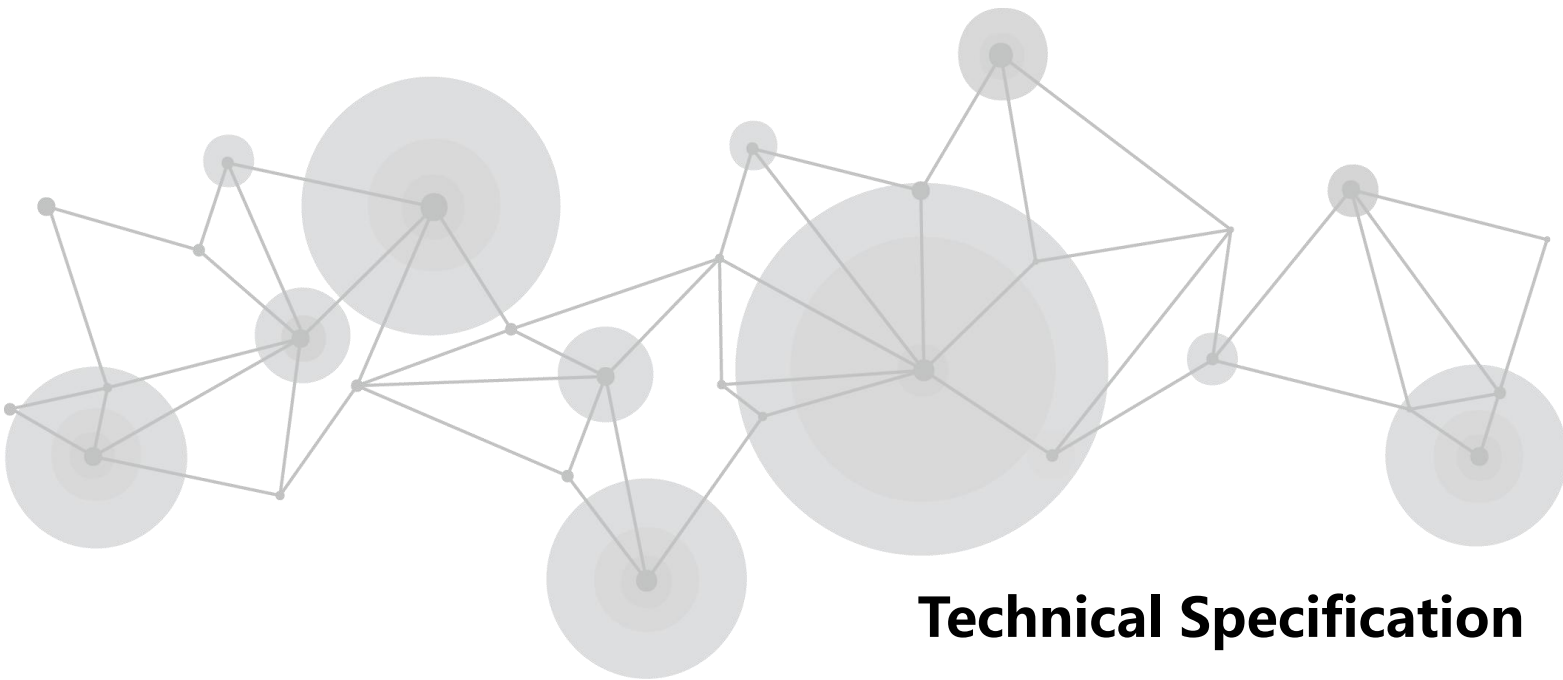

Q16pro Gen2

Multi-Window Splicing Processor



Technical Specification

Revision History

Version	Date	Description	Principal
V1.0	2023-03-30	First Release	Aster
V1.1	2023-05-06	Revise order codes	Aster
V1.2	2023-06-15	1. Add input&output module parameters 2. Add notes and cautions	Aster
V1.3	2023-08-17	1. Add 4U net & packaged weights、 module weights、 video source specifications 2. Update dual HDMI 2.0 output module resolution	Aster
V1.4	2023-09-06	Add frame rate & overall bandwidth of HDMI 1.3、 DVI、 HDMI 2.0 input and output modules	Aster
V1.5	2023-12-19	Add optional input and output modules	Aster
V1.6	2024-01-12	1. Add specification: dual HDMI 1.3 & dual DVI input module、 dual HDMI 1.3 output module with Dante、 streaming output module、 quad input & quad output analog audio module 2. Add dimension drawing: 8U model、 module	Aster
V1.7	2024-03-13	1. Add 8U model: front panel, rear panel 2. Add specification: quad HDBaseT input module 、 quad HDBaseT output module	Aster
V1.8	2024-04-17	Add single card decoding capability (IP input module)	Aster
V1.9	2024-07-23	Upgrade point: support 16 layers	Aster
V2.0	2024-10-31	1. Add single card decoding capability (IP input module) 2. Add Streaming Output Module NDI coding	Rainbow
V2.1	2025-02-13	3. Change some of the order codes	Alyssa

Product Overview

Q16pro Gen2 adopts a high-performance video image processing system with a pure hardware wire-speed processing architecture, which is suitable for education and scientific research, government announcements, information publishing, administrative management, military command, exhibitions, security monitoring, commercial sales and other industries.

The modular input and output card structure is adopted, and the arbitrary mixing function of the input card is realized at the same time. Not only can it easily access the common HDMI/DVI/SDI/IP/AUDIO/DANTE/HDBASET and other multiple signals, but also support DP 1.2, HDMI 2.0 and other ultra-high resolution 4K/8K signal input and output, easily realize 4K multi-screen point-to-point splicing.

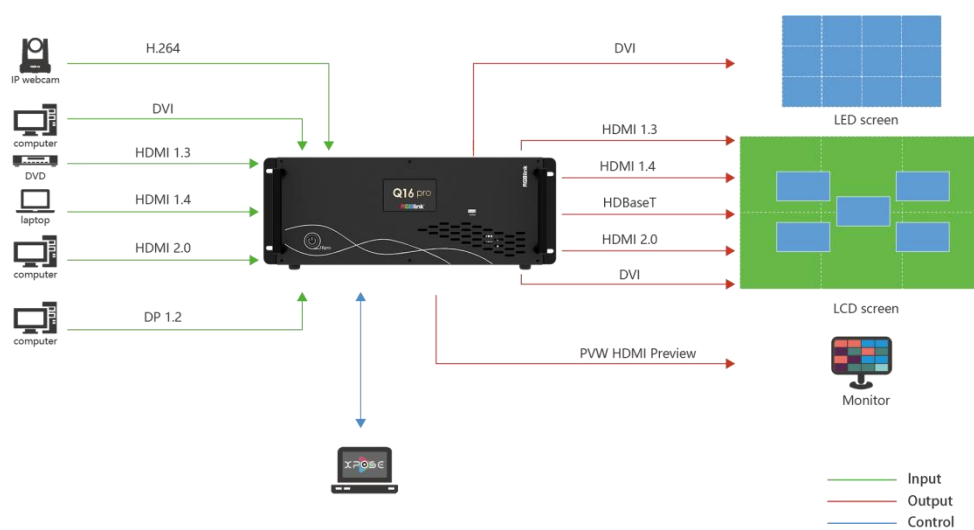

Features

Inputs & Outputs

- **7 types of pluggable input modules, user configurable**
 - * Quad HDMI 1.3 Input Module
 - * Dual HDMI 2.0 & Dual DP 1.2 Input Module
 - * Quad 3G SDI (LOOP) Input Module
 - * Quad DVI Input Module
 - * Single IP Input Module
 - * Dual HDMI 1.3 & Dual DVI Input Module
 - * Quad HDBaseT Input Module
- **Pluggable communication module**
 - * Communication Module with PVW
- **8 types of pluggable output modules, user configurable**
 - * Quad HDMI 1.3 Output Module
 - * Quad 3G SDI Output Module
 - * Quad DVI Output Module
 - * Dual HDMI 2.0 Output Module
 - * Dual HDMI 1.3 Output Module with Dante
 - * Streaming Output Module
 - * Quad HDBaseT Output Module
 - * Quad Input & Quad Output Analog Audio Module
- **Power module**
 - * 2U and above support redundant power module

Key Features

- Each module supports 16 screens spanning the output port without occupying layers
- LOGO overlay
- Dual independent OSD rolling subtitles
- Multi-window monitoring for inputs
- i signal output supported
- 12 bit input and output, RGB 4:4:4 color space
- Seamless switch between signals and scenes
- Dual power module backup

Device Controls

- **XPOSE Software Control**
Q16pro Gen2 can be connected to the XPOSE software for smart and convenient device management.
- **Cascading Control via Ethernet**
The Ethernet control port supports UDP protocol and star topology. Can achieve device cascading and communication on the same LAN.

Appearance

Front Panel

2U



4U

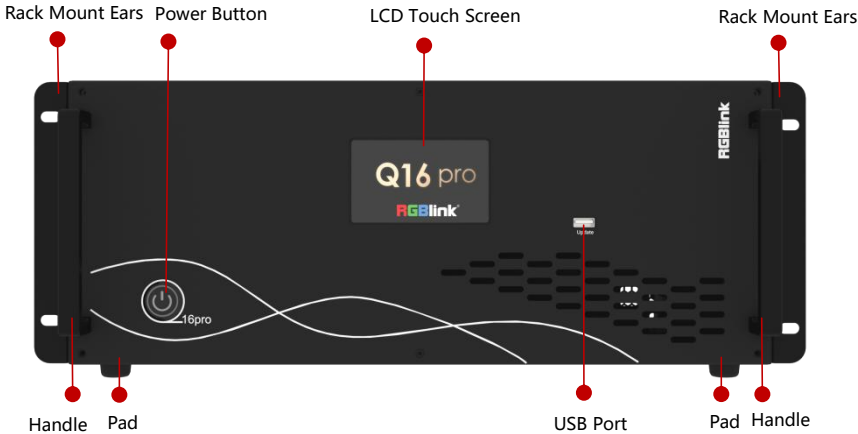

8U

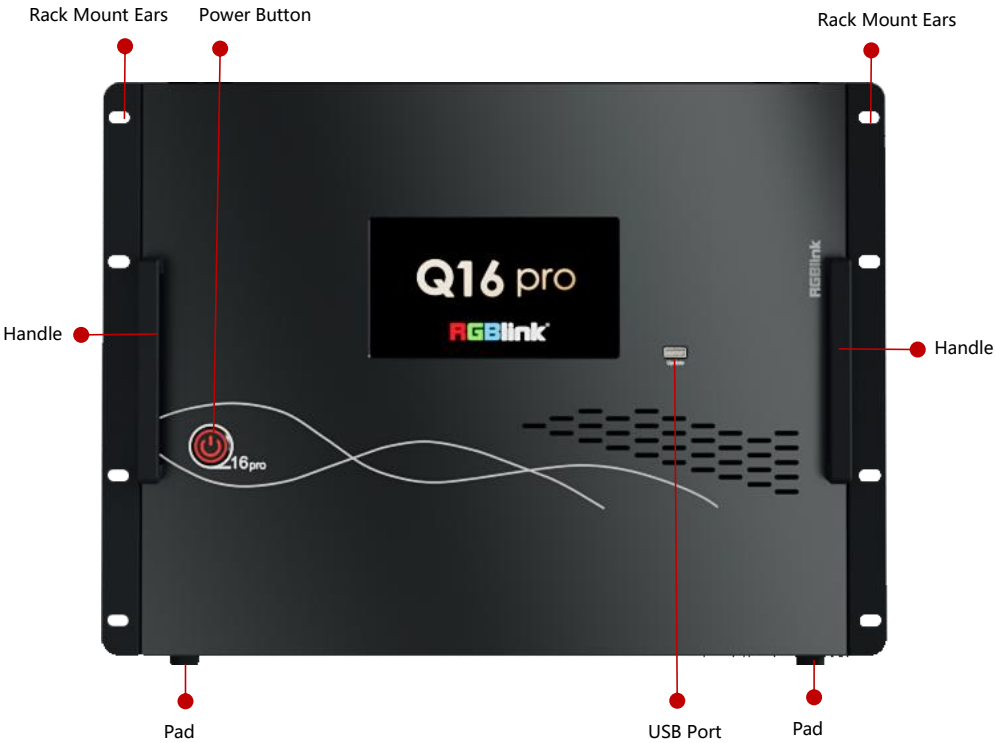

Name	Description
LCD Touch Screen	<ul style="list-style-type: none"> • Display current status of the device. • For menu operation.
Power Button	<ul style="list-style-type: none"> • Press the button to power on or power off the device. • Button light turns red when powered on.
USB Port	Used for device upgrade.
Handles	For carrying device.
Rack Mount Ears	Use with the load-bearing screws to fix device on the rack.

Rear Panel

2U



4U



Power Supply Module

Communication Slot

Ground Screw

Interface Protector Input Slots Output Slots Interface Protector



Communication Slot

Power Supply Module (standard)

Power Supply Module (backup)

Ground Screw

8U



Interface Protector Input Slots Output Slots Communication Slot Interface Protector



Ground Screw

Power Supply Module (standard)

Power Supply Module (backup)

Name	Description
Input Slots	<ul style="list-style-type: none"> Support quad HDMI 1.3, quad DVI, quad 3G SDI (LOOP), dual HDMI 2.0 & dual DP 1.2, single IP, dual HDMI 1.3 & dual DVI, quad HDBaseT input module  purple tip indicates input
Output Slots	<ul style="list-style-type: none"> Support quad HDMI 1.3, quad 3G SDI, quad DVI, dual HDMI 2.0, dual HDMI 1.3 with Dante, quad HDBaseT, streaming output module, quad input & quad output analog audio module Support input modules  blue tip indicates output
Communication Module	<ul style="list-style-type: none"> Communication module with PVW  yellow tip indicates communication
Power Module	IEC power socket
Interface Protector	Used to pull out device, fix cables and protect interfaces from collision
Ground Screw	Increase the safety and reliability, and avoid accidents such as fire and explosion caused by static electricity.

Module Specification

INPUT MODULE		
Input Module 1: Quad HDMI 1.3 Input Module		
		Key Features <ul style="list-style-type: none"> Fully modular architecture Support HDMI (with HDCP) inputs Input resolution up to 2048×1080@60Hz EDID management Support hot swap
Connectors	Input	4xHDMI-A
Performance	Resolution	SMPTE 720x480p@60 720x576p@50 1280x720p@23.98/24/25/29.97/30/50/59.94/60 1920x1080i@50/59.94/60 1920x1080p@24/25/29.97/30/50/59.94/60 Custom
		VESA 1024x768p@60/75/85 1280x800p@60 1280x1024p@60/75/85 1360x768p@60 1366x768p@60 1440x900p@60 1400x1050p@60 1680x1050p@60 1920x1080p@60 1920x1200p@60 Custom
	Custom Resolutions	1536x960@60 1840x960@60 1920x1152@60 1872x1152@60 Note: Resolutions listed above have been tested already, for other custom resolutions not mentioned, please refer to the actual use.
	Max Width/Height	<ul style="list-style-type: none"> Max width: 2048 (2048x1080@60) Max height: 1200 (1920x1200@60)
	Frame Rate	≤240Hz
	Overall Bandwidth	≥235W
	EDID Management	Support HDMI 1.3
	HDCP	HDCP 1.X compliant
	Transmission Rate	≤20Gbps
	Transmission Cable Length	≤100m
Physical	Weight	0.27kg
	Dimension	202mm x 190.8mm x 20mm
Order Code	Product Code	790-1002-31-1

INPUT MODULE		
Input Module 2: Quad DVI Input Module		
		<p>Key Features</p> <ul style="list-style-type: none"> • Fully modular architecture • Quad standard DVI input signals • Input resolution up to 2048×1080@60Hz • EDID management • Support hot swap
Connectors	Input	4xDVI-I
Performance	Resolution	<p>SMPTE</p> <p>720x480p@60 720x576p@50 1280x720p@23.98/24/25/29.97/30/50/59.94/60 1920x1080i@50/59.94/60 1920x1080p@24/25/29.97/30/50/59.94/60 Custom</p>
		<p>VESA</p> <p>1024x768p@60/75/85 1280x800p@60 1280x1024p@60/75/85 1360x768p@60 1366x768p@60 1440x900p@60 1400x1050p@60 1680x1050p@60 1920x1080p@60 1920x1200p@60 Custom</p>
	Custom Resolutions	<p>1536x960@60 1840x960@60 1920x1152@60 1872x1152@60</p> <p>Note: Resolutions listed above have been tested already, for other custom resolutions not mentioned, please refer to the actual use.</p>
	Max Width/Height	<ul style="list-style-type: none"> • Max width: 2048 (2048x1080@60) • Max height: 1200 (1920x1200@60)
	Frame Rate	≤240Hz
	Overall Bandwidth	≥235W
	EDID Management	Support DVI 1.0 / HDMI 1.3
	HDCP	HDCP 1.X compliant
	Transmission Rate	≤20Gbps
	Transmission Cable Length	≤100m
Physical	Weight	0.27kg
	Dimension	202mm x 190.8mm x 20mm
Order Code	Product Code	790-1002-35-1

INPUT MODULE		
Input Module 3: Dual HDMI 1.3 & Dual DVI Input Module		
		Key Features <ul style="list-style-type: none"> • Fully modular architecture • Support HDMI (with HDCP) inputs • Input resolution up to 2048×1080@60Hz • EDID management • Support hot swap
Connectors	Input	2xHDMI-A 2xDVI-I
Performance	Resolution	SMPTE 720x480p@60 720x576p@50 1280x720p@23.98/24/25/29.97/30/50/59.94/60 1920x1080i@50/59.94/60 1920x1080p@24/25/29.97/30/50/59.94/60 Custom VESA 1024x768p@60/75/85 1280x800p@60 1280x1024p@60/75/85 1360x768p@60 1366x768p@60 1440x900p@60 1400x1050p@60 1680x1050p@60 1920x1080p@60 1920x1200p@60 Custom
	Custom Resolutions	1536x960@60 1840x960@60 1920x1152@60 1872x1152@60 Note: Resolutions listed above have been tested already, for other custom resolutions not mentioned, please refer to the actual use.
	Max Width/Height	<ul style="list-style-type: none"> • Max width: 2048 (2048x1080@60) • Max height: 1200 (1920x1200@60)
	Frame Rate	≤240Hz
	Overall Bandwidth	≥235W
	EDID Management	Support DVI 1.0 / HDMI 1.3
	HDCP	HDCP 1.X compliant
	Transmission Rate	≤20Gbps
	Transmission Cable Length	≤100m
	Physical	Weight
Dimension		202mm x 190.8mm x 20mm
Order Code	Product Code	790-1002-44-1

INPUT MODULE		
Input Module 4: Quad 3G SDI (LOOP) Input Module		
		Key Features <ul style="list-style-type: none"> Fully modular architecture Input resolution up to 1920×1080@60Hz Support I/P signal input Support hot swap
Connectors	Input	8xBNC (4 IN 4 LOOP)
Performance	Resolution	SMPTE 480i@60 720x480p@60 576i@50 1280x720p@50/59.94/60 1920x1080 i@50/59.94/60 1920x1080p@23.98/24/25/29.97/30/50/59.94/60
		VESA 1920x1080p@60
	Standard	<ul style="list-style-type: none"> Support ST-424 (3G), ST292 (HD) standard video inputs. Support 3G-Level A/Level B (DS mode).
	Frame Rate	≤240Hz
	Overall Bandwidth	≥207W
	Interlaced Signal Inputs	Support
	Transmission Rate	≤20Gbps
	Transmission Cable Length	≤100m
Physical	Weight	0.40kg
	Dimension	202mm x 190.8mm x 20mm
Order Code	Product Code	790-1002-34-1

INPUT MODULE		
Input Module 5: Dual HDMI 2.0 & Dual DP 1.2 Input Module		
		<p>Key Features</p> <ul style="list-style-type: none"> • Fully modular architecture • Support HDMI(with HDCP) inputs • Input resolution up to 3840×2160@60Hz • EDID management • Support hot swap • Choose one 4K60 input signal or two 4K30 input signals to use
Connectors	Input	2xHDMI-A 2xDP
Performance	Resolution	<p>SMPTE</p> <p>480i@60 720x480p@60 576i@50 720x576p@50 1280x720p@50/59.94/60 1920x1080p@23.98/24/25/29.97/30/50/59.94/60 3840x1080p@30/60 3840x2160p@25/30/50/60 Custom</p> <p>VESA</p> <p>640x480p@60/75/85 800x600p@60/75/85 1024x768p@60/75/85 1280x800p@60 1280x1024p@60/75/85 1360x768p@60 1366x768p@60 1440x900p@60 1400x1050p@60 1366x768p@60 1680x1050p@60 1920x1080p@60 1920x1200p@60 2048x1152p@60 2560x1440p@60 2560x1600p@60 3840x2160p@25/30/50/60</p>
	Max Width/Height	<ul style="list-style-type: none"> • Max width: 3840 • Max height: 2160
	Frame Rate	≤240Hz
	Overall Bandwidth	≥829W
	EDID Management	Support HDMI 2.0 / HDMI 1.4 / HDMI 1.3
	HDCP	HDCP 2.2 compliant
	Transmission Rate	≤20Gbps
	Transmission Cable Length	≤100m
Physical	Weight	0.27kg
	Dimension	202mm x 190.8mm x 20mm
Order Code	Product Code	790-1002-33-1

INPUT MODULE		
Input Module 6: Single IP Input Module		
		<p>Key Features</p> <ul style="list-style-type: none"> • Fully modular architecture • Max support 16-channel 540p60 decoding • Support RTSP/RTMP network protocol • Support NDI protocol transmission • Support hot swap
Connectors	Input	1xUSB-A 1xRJ45 Gigabit Network Port
Performance	Resolution	<p>SMPTE</p> <p>720p@30/50/60 1080p@30/50/60 2160p@30/60</p>
	Network Protocol	<ul style="list-style-type: none"> • RTSP • RTMP • NDI 6
	Decoding Standard	<ul style="list-style-type: none"> • H.265 Main Profile Level 5.1 • H.264 Baseline/Main/High Profile Level 5.0 • NDI HX • NDI HX2, NDI HX3 • Full NDI (planned)
	Decoding Resolution	<ul style="list-style-type: none"> • 1-channel: 3840x2160@60 • 4-channel: 1920x1080@60 • 16-channel: 960x540@60
	Single Card Decoding Capability	<ul style="list-style-type: none"> • 1-channel: 3840x2160@60fps • 4-channel: 3840x2160@30fps 1920x1080@60fps • 16-channel: 1920x1080@30fps
	Transmission Cable Length	≤100m
	Physical	Weight
	Dimension	202mm x 190.8mm x 20mm
Order Code	Product Code	790-1002-32-1

INPUT MODULE		
Input Module 7: Quad HDBaseT Input Module		
		Key Features <ul style="list-style-type: none"> • Fully modular architecture • Resolution up to 1920×1080@60 • Extend up to 100m • Uncompressed audio and video transmission • Support hot swap
Connectors	Input	4xRJ45
Performance	Resolution	SMPTE 720p@30/50/60 1080p@30/50/60 2160p@30/60
		VESA 800×600@60 1024×768@60 1280×768@60 1280×1024@60 1600×1200@60 1920×1080@60
	Transmission Rate	≤20Gbps
	Transmission Cable Length	≤100m
Physical	Weight	0.30kg
	Dimension	202mm x 190.8mm x 20mm
Order Code	Product Code	790-1002-46-1

OUTPUT MODULE		
Output Module 1: Quad HDMI 1.3 Output Module		
		Key Features <ul style="list-style-type: none"> • Fully modular architecture • Output resolution up to 2048×1152@60Hz • Support hot swap
Connectors	Output	4xHDMI-A
Performance	Resolution	SMPTE/VESA 1024x768p@60 1280x720p@50/59.94/60 1280x800p@60 1280x1024p@60 1360x768p@60 1366x768p@60 1400x1050p@60 1440x900p@60 1600x1200p@60 1680x1050p@60 1920x1080p@23.98/24/25/29.97/30/50/ 59.94/60 1920x1200p@60 2560x816p@60 2048x1152p@60 Custom
	Custom Resolutions	1536x960p@60 1840x960p@60 1920x1152p@60 1920x1200p@60 1872x 1152p@60 2048x1152p@60 1536x1536p@60 2048x1080p@60 2304x 1080p@60 2560x960p@60 3840x640p@60 3840x1080p@30 640x3840p @30/50 512x3840p@50 1152x1536p@60 Note: Resolutions listed above have been tested already, for other custom resolutions not mentioned, please refer to the actual use.
	Max Width/Height	<ul style="list-style-type: none"> • Max width: 3840 (3840x640p@60) • Max height: 3840 (640x3840p@50)
	Frame Rate	≤240Hz
	Overall Bandwidth	≥245W
	Transmission Rate	≤20Gbps
	Transmission Cable Length	≤100m
	Physical	Weight
Dimension		202mm x 190.8mm x 20mm
Order Code	Product Code	790-1002-36-1

OUTPUT MODULE		
Output Module 2: Quad DVI Output Module		
		Key Features <ul style="list-style-type: none"> Fully modular architecture Output resolution up to 2048x1152@60Hz Support hot swap
Connectors	Output	4xDVI-I
Performance	Resolution	SMPTE/VESA 1024x768p@60 1280x720p@50/59.94/60 1280x800p@60 1280x1024p@60 1360x768p@60 1366x768p@60 1400x1050p@60 1440x900p@60 1600x1200p@60 1680x1050p@60 1920x1080p@23.98/24/25/29.97/30/50/59.94/60 1920x1200p@60 2560x816p@60 2048x1152p@60 Custom
	Custom Resolutions	1536x960p@60 1840x960p@60 1920x1152p@60 1920x1200p@60 1872x1152p@60 2048x1152p@60 1536x1536p@60 2048x1080p@60 2304x1080p@60 2560x960p@60 3840x640p@60 3840x1080p@30 640x3840p@30/50 512x3840p@50 1152x1536p@60 Note: Resolutions listed above have been tested already, for other custom resolutions not mentioned, please refer to the actual use.
	Max Width/Height	<ul style="list-style-type: none"> Max width: 3840 (3840x640p@60) Max height: 3840 (640x3840p@50)
	Frame Rate	≤240Hz
	Overall Bandwidth	≥245W
	Transmission Rate	≤20Gbps
	Transmission Cable Length	≤100m
	Physical	Weight
Dimension		202mm x 190.8mm x 20mm
Order Code	Product Code	790-1002-41-1

OUTPUT MODULE		
Output Module 3: Quad 3G SDI Output Module		
		Key Features <ul style="list-style-type: none"> • Fully modular architecture • Output resolution up to 1920x1080@60Hz • Support hot swap
Connectors	Output	4xBNC
Performance	Resolution	SMPTE 1280x720p@50/59.94/60 1920x1080p@23.98/24/25/29.97/30/50/59.94/60
	Frame Rate	≤240Hz
	Overall Bandwidth	≥207W
	Transmission Rate	≤20Gbps
	Transmission Cable Length	≤100m
Physical	Weight	0.34kg
	Dimension	202mm x 190.8mm x 20mm
Order Code	Product Code	790-1002-40-1

OUTPUT MODULE		
Output Module 4: Dual HDMI 2.0 Output Module		
		Key Features <ul style="list-style-type: none"> • Fully modular architecture • Output resolution up to 4096×2160@60Hz • Support hot swap
Connectors	Output	2xHDMI-A
Performance	Resolution	SMPTE/VESA 1024x768p@60 1280x720p@50/59.94/60 1280x800p@60 1280x1024p@60 1360x768p@60 1400x1050p@60 1440x900p@60 1600x1200p@60 1680x1050p@60 1920x1080p@23.98/24/25/29.97/30/50/59.94/60 1920x1200p@60 2560x816p@60 2048x1152p@60 2560x1440p@60 2560x1600p@60 3840x1080p@30/60 3840x2160p@50/59.94/60 4096x2160p@25/50/59.94/60 Custom
	Custom Resolutions	1024x768@60 1280x720@50/59.94/60 1280x800@60 1280x1024@60 1360x768@60 1400x1050@60 1440x900@60 1600x1200@60 1680x1050@60 1920x1080@23.98/24/25/29.97/30/50/59.94/60 1920x1200@60 2560x816@60 2048x1152@60 2560x1440@60 2560x1600@60 3840x1080@60 3840x2160@50/59.94/60 4096x2160@25/50/59.94/60 Note: Resolutions listed above have been tested already, for other custom resolutions not mentioned, please refer to the actual use.
	Max Width/Height	<ul style="list-style-type: none"> • Max width: 4096 (4096x2160p@60) • Max height: 2160 (4096x2160p@60)
	Frame Rate	≤240Hz
	Overall Bandwidth	≥884W
	Transmission Rate	≤20Gbps
	Transmission Cable Length	≤100m
	Physical	Weight
Dimension		202mm x 190.8mm x 20mm
Order Code	Product Code	790-1002-38-1

OUTPUT MODULE		
Output Module 5: Quad HDBaseT Output Module		
		<p>Key Features</p> <ul style="list-style-type: none"> • Fully modular architecture • Resolution up to 1920×1080@60 • Support cropping, scaling and roaming of 16 layers • Extend up to 100m` • Support hot swap
Connectors	Output	4xRJ45
Performance	Resolution	<p>SMPTE</p> <p>720p@30/50/60 1080p@30/50/60 2160p@30/60</p>
		<p>VESA</p> <p>800×600@60 1024×768@60 1280×768@60 1280×1024@60 1600×1200@60 1920×1080@60</p>
	Transmission Rate	≤20Gbps
	Transmission Cable Length	≤100m
Physical	Weight	0.30kg
	Dimension	202mm x 190.8mm x 20mm
Order Code	Product Code	790-1002-47-1

OUTPUT MODULE					
Output Module 6: Streaming Output Module					
		<p>Key Features</p> <ul style="list-style-type: none"> • Fully modular architecture • Output resolution up to 3840×2160@60Hz • HDMI2.0 preview • USB 3.0 recording • Streaming via LAN port and USB-C port • Support simultaneous streaming to 2 platforms via RTMP, RTMPS, NDI • Support hot swap 			
Connectors	Output	1xHDMI-A 1xUSB-A 1xRJ45 Gigabit Network Port 1xUSB-C			
Performance	Resolution	<p>SMPTE</p> <p>720p@50/60 1080p@23.98/24.97/50/59.94/60 2160p@50/60</p> <p>VESA</p> <p>1024×768@60 1280×720@50/60 1280×768@60 1280×1024@60 1360×768@60 1920×1080@60 3840×2160@60</p>			
		<table border="1"> <tr> <td>Video Formats</td> <td>HDCP 2.2</td> </tr> <tr> <td>Video Latency</td> <td>≥1 frame</td> </tr> </table>	Video Formats	HDCP 2.2	Video Latency
	Video Formats	HDCP 2.2			
	Video Latency	≥1 frame			
	Record/Storage	Record Formats	MP4		
		Disk Formats	FAT32(≤32 GB) exFAT(64GB~2T)		
	Supported Standards	USB	3.0		
		H.265	ITU-T H.265/ ISO/IEC 23008-2		
	Coding performance	Support H.264 H.265 NDI 6			
	NDI coding	NDI HX,NDI HX2,NDI HX3 Full NDI (planned)			
	RTMP coding	Support streaming software			
	Speed mode	CBR, VBR, FIXQP, AVBR, QPMAP			
Maximum output speed	125Mbps				
Transmission Cable Length	≤100m				
Physical	Weight	0.28kg			
	Dimension	202mm x 190.8mm x 20mm			
Order Code	Product Code	790-1002-45-1			

OUTPUT MODULE

Output Module 7: Quad Input & Quad Output Analog Audio Module

		<p>Key Features</p> <ul style="list-style-type: none"> • Fully modular architecture • Support volume adjustment • Support 4 inputs and 4 outputs • Video and audio switch synchronously • Support audio setting of different banks • Support extra any digital and analog audio • Support hot swap 																		
		<table border="1"> <tr> <td rowspan="2">Connectors</td> <td>Input</td> <td>4×3.5mm audio jack</td> </tr> <tr> <td>Output</td> <td>4×3.5mm audio jack</td> </tr> <tr> <td rowspan="3">Performance</td> <td>Sound Channel</td> <td>Stereo, Double Channels</td> </tr> <tr> <td>Transmission Rate</td> <td>≤20Gbps</td> </tr> <tr> <td>Transmission Cable Length</td> <td>≤100m</td> </tr> <tr> <td rowspan="2">Physical</td> <td>Weight</td> <td>0.30kg</td> </tr> <tr> <td>Dimension</td> <td>202mm x 190.8mm x 20mm</td> </tr> <tr> <td>Order Code</td> <td>Product Code</td> <td>790-1002-28-1</td> </tr> </table>	Connectors	Input	4×3.5mm audio jack	Output	4×3.5mm audio jack	Performance	Sound Channel	Stereo, Double Channels	Transmission Rate	≤20Gbps	Transmission Cable Length	≤100m	Physical	Weight	0.30kg	Dimension	202mm x 190.8mm x 20mm	Order Code
Connectors	Input	4×3.5mm audio jack																		
	Output	4×3.5mm audio jack																		
Performance	Sound Channel	Stereo, Double Channels																		
	Transmission Rate	≤20Gbps																		
	Transmission Cable Length	≤100m																		
Physical	Weight	0.30kg																		
	Dimension	202mm x 190.8mm x 20mm																		
Order Code	Product Code	790-1002-28-1																		

OUTPUT MODULE		
Output Module 8: Dual HDMI 1.3 Output Module with Dante		
		<p>Key Features</p> <ul style="list-style-type: none"> • Fully modular architecture • Dante input and outputs with up to 32 audio channels supported • Output resolution up to 2048×1152@60Hz • Switching between Dante audio and HDMI 1.3 embedded audio • Audio volume adjustment • Audio mixing • Lossless audio transmission with low latency • Support hot swap
Connectors	Output	2xHDMI-A 2xRJ45
Performance	Resolution	<p>SMPTE/VESA</p> <p>1024x768p@60 1280x720p@50/59.94/60 1280x800p@60 1280x1024p@60 1360x768p@60 1366x768p@60 1400x1050p@60 1440x900p@60 1600x1200p@60 1680x1050p@60 1920x1080p@23.98/24/25/29.97/30/50/59.94/60 1920x1200p@60 2560x816p@60 2048x1152p@60 Custom</p>
	Custom Resolutions	<p>1536x960p@60 1840x960p@60 1920x1152p@60 1920x1200p@60 1872x1152p@60 2048x1152p@60 1536x1536p@60 2048x1080p@60 2304x1080p@60 2560x960p@60 3840x640p@60 3840x1080p@30 640x3840p@30/50 512x3840p@50 1152x1536p@60</p> <p>Note: Resolutions listed above have been tested already, for other custom resolutions not mentioned, please refer to the actual use.</p>
	Max Width/Height	<ul style="list-style-type: none"> • Max width: 3840 (3840x640p@60) • Max height: 3840 (640x3840p@50)
	Sampling Rate	48KHZ
	Frame Rate	≤240Hz
	Overall Bandwidth	≥245W
	Transmission Rate	≤20Gbps
	Transmission Cable Length	≤100m
Physical	Weight	0.31kg
	Dimension	202mm x 190.8mm x 20mm
Order Code	Product Code	790-1002-43-1

COMMUNICATION MODULE		
Communication Module: Communication Module with PVW		
		Key Features <ul style="list-style-type: none"> • Fully modular architecture • Support hot swap
Connectors	Type	Description
	1xPVW (HDMI)	Used for multi-window monitoring
	1xIP (H.265)	Used for remote control and IP echo
	1xLAN	Connected to router or control PC to realize software control
	1xRS232	Connected to router or control PC to realize software control or device upgrade
	1xUSB	Used for device upgrade
	1xTRS	Used for audio monitoring
	1xIN-GENLOCK-LOOP	Connected to a synchronization signal <ul style="list-style-type: none"> • IN: Used to accept the sync signal • LOOP: Used to loop the sync signal
Physical	Weight	0.30kg
	Dimension	202mm x 190.8mm x 20mm
Order Code	Product Code	790-1002-22-0

Dimensions

Dimension of Q16pro Gen2 2U: 483.4mmx377mmx89mm

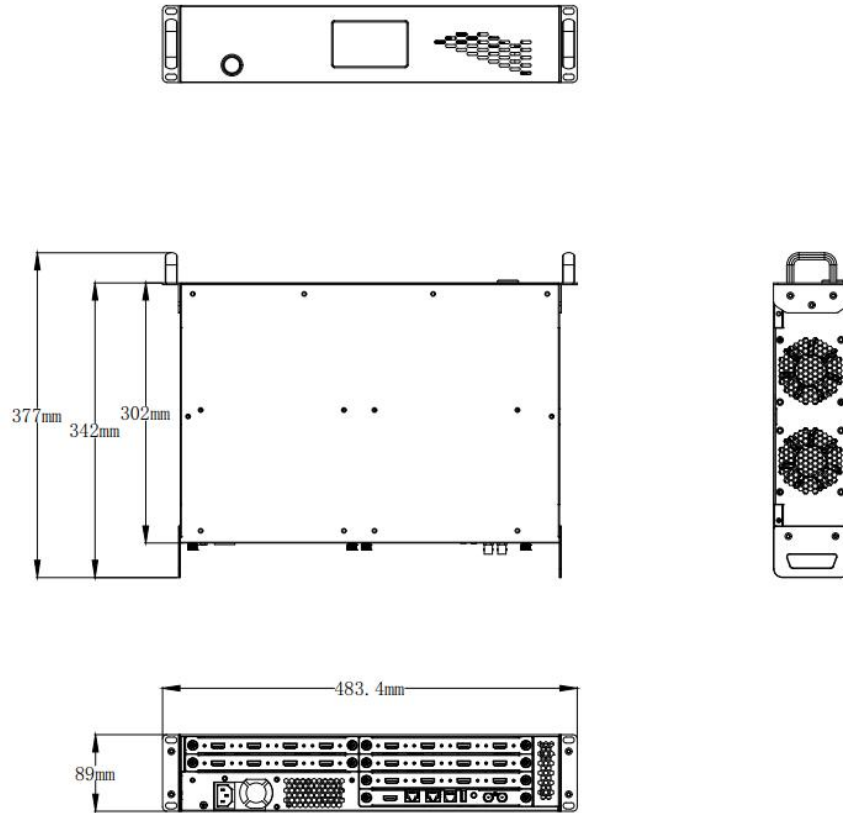

Dimension of Q16pro Gen2 4U: 483mm x 376mm x 178mm

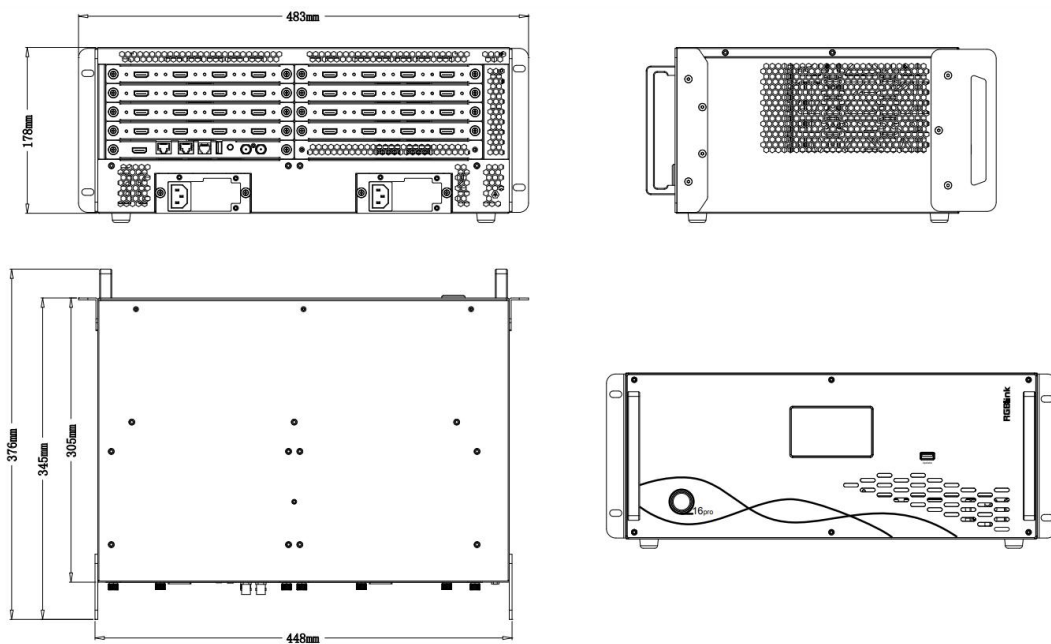

Dimension of Q16pro Gen2 8U: 488mm x 370mm x 355.6mm

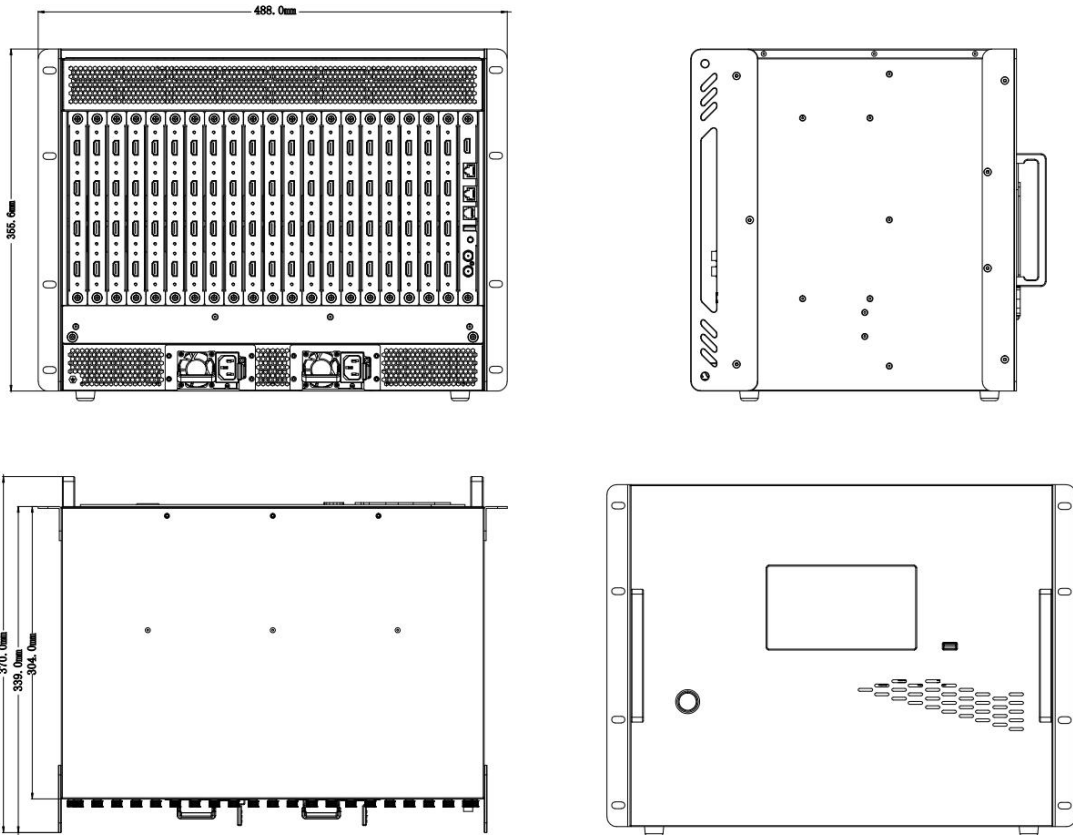

Dimension of module: 202mm x 190.8mm x 20mm

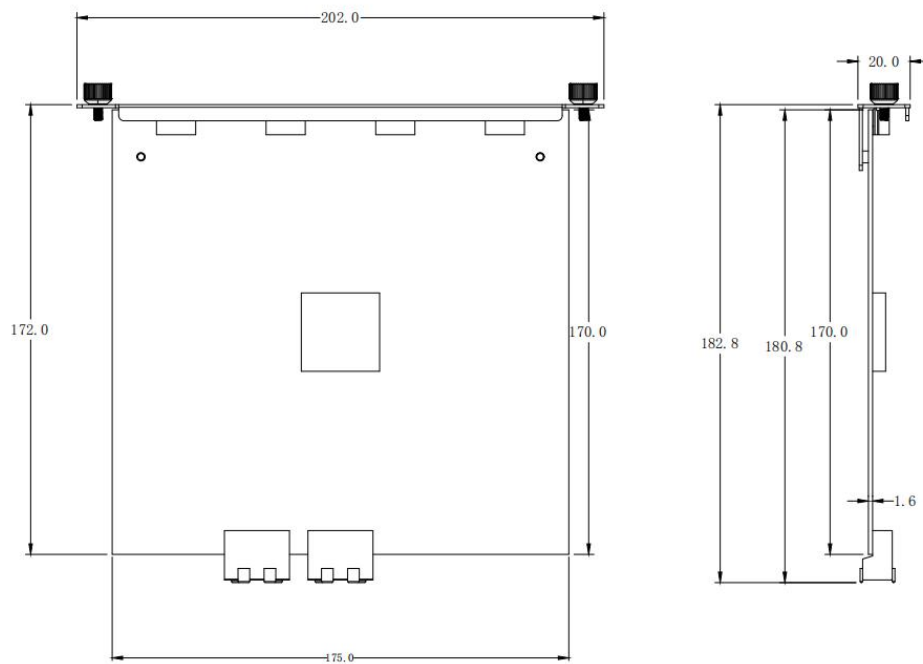

unit: mm

Product Technical Specification

Model		Q16pro Gen2 2U	Q16pro Gen2 4U	Q16pro Gen2 8U	
Specification		2U	4U	8U	
Input Slots (max)		3	8	18	
Output Slots (max)		2	4	10	
Shared Slots		no support	Output slot No. 1~4	Output slot No. 1~8	
Physical	Net Dimension	483.4x377x89mm	483.4x376x178mm	488x370x355.6mm	
	Package Dimension	630x585x250mm	645x525x295mm	585x460x520mm	
	Net Weight	5.53kg	7.24kg	13.42kg	
	Package Weight	9.25kg	11.47kg	18.42kg	
	Module	Input Module			
	Weight	Quad HDMI 1.3	0.27kg	Quad DVI	0.27kg
		Dual HDMI 1.3 & Dual DVI	0.27kg	Quad 3G SDI (LOOP)	0.40kg
		Dual HDMI 2.0 & Dual DP 1.2	0.27kg	Single IP	0.26kg
		Quad HDBaseT	0.30kg		
		Output Module			
		Quad HDMI 1.3	0.28kg	Quad DVI	0.28kg
		Quad 3G SDI	0.34kg	Dual HDMI 2.0	0.26kg
		Analog Audio Module	0.30kg	Streaming Module	0.28kg
		Quad HDBaseT	0.30kg	Dual HDMI 1.3 with Dante	0.31kg
		Others			
	300W Redundant Power	0.74kg	Communication Module with PVW	0.30kg	
	550W Redundant Power	TBC			
What's included	1 x Network Cable	1 x Power Cable	1 x RS232 to RJ11 Cable		
	1 x DVI Cable	1 x HDMI Cable			
Standards	Supported Standards	SDI	SD/HD/3G		
		HDMI	2.0		
		DVI	1.0		
		DP	1.2		
		H.265	H.265		
		HDBaseT	1.0		
Power	Input Voltage	AC 100V-240V, 50/60Hz (2U and above support dual PSU.)			
Working Environment	Temperature	0°C ~ 45°C			
	Humidity	15%~85%, RH			
Storage Environment	Temperature	0°C~55°C			
	Humidity	5% ~ 85%, RH			

Video Source Specifications

INPUT		Features		
		Bit Depth	Color Space/Sampling	Input Resolutions
Input Module 1	HDMI 2.0	8bit	RGB4:4:4	3840x2160@60
			YCbCr4:4:4	
			YCbCr4:2:2	
Input Module 2	HDMI 1.3	8bit	RGB4:4:4	1920x1080@60
			YCbCr4:4:4	
			YCbCr4:2:2	
		10bit/12bit	RGB4:4:4	≥1280x720@60
			YCbCr4:4:4	
			YCbCr4:2:2	
Input Module 3	DVI	8bit	RGB4:4:4	1920x1080@60
			YCbCr4:4:4	
			YCbCr4:2:2	
		10bit/12bit	RGB4:4:4	≥1280x720@60
			YCbCr4:4:4	
			YCbCr4:2:2	
Input Module 4	SDI	10bit	YCbCr4:2:2	1920x1080@60
	Note	<ul style="list-style-type: none"> For requirements of other resolutions, frame rates and bit depths on input module, please contact RGBlink for customization. 		
OUTPUT		Features		
		Bit Depth	Color Space/Sampling	Output Resolutions
Output Module 1	HDMI 1.3	8bit	RGB4:4:4	1920x1080@60
			YCbCr4:4:4	
			YCbCr4:2:2	
		10bit/12bit	RGB4:4:4	≥1280x720@60
			YCbCr4:4:4	
			YCbCr4:2:2	

Specifications are correct at time of printing and subject to change or alteration without notice.

Notes and Cautions

Notes for Battery

The general safety information in this summary is for operating personnel.

- **Do Not Remove Covers or Panels** — There are no user-serviceable parts within the unit. Removal of the top cover will expose dangerous voltages. To avoid personal injury, do not remove the top cover. Do not operate the unit without the cover installed.
- **Power Source** — This product is intended to operate from a power source that will not apply more than 230 volts rms between the supply conductors or between both supply conductor and ground. A protective ground connection by way of grounding conductor in the power cord is essential for safe operation.
- **Grounding the Product** — This product is grounded through the grounding conductor of the power cord. To avoid electrical shock, plug the power cord into a properly wired receptacle before connecting to the product input or output terminals. A protective-ground connection by way of the grounding conductor in the power cord is essential for safe operation.
- **Use the Proper Power Cord** — Use only the power cord and connector specified for your product. Use only a power cord that is in good condition. Refer cord and connector changes to qualified service personnel.
- **Use the Proper Fuse** — To avoid fire hazard, use only the fuse having identical type, voltage rating, and current rating characteristics. Refer fuse replacement to qualified service personnel.
- **Do Not Operate in Explosive Atmospheres** — To avoid explosion, do not operate this product in an explosive atmosphere.

Notes for Installation

When the product needs to be installed on the rack, 4 screws at least M5*12 should be used to fix it. The rack for installation shall bear at least 42kg weight.

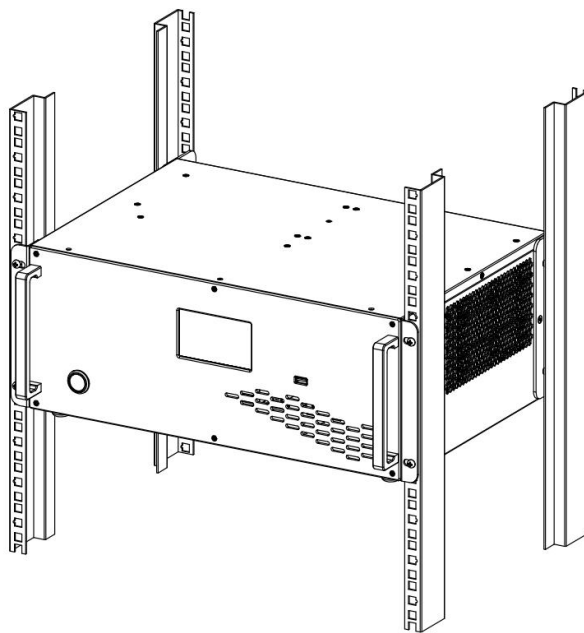

- **Safety Precautions** — To protect users from electric shock, ensure that the chassis connects to earth via the ground wire provided in the AC power Cord. The AC Socket-outlet should be installed near the equipment and be easily accessible.
- **Unpacking and Inspection** — Before opening device shipping box, inspect it for damage. If you find any damage, notify the shipping carrier immediately for all claims adjustments. As you open the box, compare its contents against the packing slip. If you find any shortages, contact your sales representative.
- **Site Preparation** — The environment in which you install your device should be clean, properly lit, free from static, and have adequate power, ventilation, and space for all components.
- **Mechanical Loading** — Mounting of the device in the rack should be such that a hazardous condition is not achieved due to uneven mechanical loading.

Order Codes

Product Code	Item
710-1002-06-1	Q16pro Gen2 2U (Communication Module with PVW Included)
710-1002-01-0	Q16pro Gen2 4U (Communication Module with PVW Included)
710-1002-07-1	Q16pro Gen2 8U (Communication Module with PVW Included)
790-1002-31-1	Q Series Quad HDMI 1.3 Input Module
790-1002-32-1	Q Series Single IP Input Module
790-1002-33-1	Q Series Dual HDMI 2.0 & Dual DP 1.2 Input Module
790-1002-34-1	Q Series Quad 3G SDI (LOOP) Input Module
790-1002-35-1	Q Series Quad DVI Input Module
790-1002-44-1	Q Series Dual HDMI 1.3 & Dual DVI Input Module
790-1002-46-1	Q Series Quad HDBaseT Input Module
790-1002-28-1	Q Series Quad Input & Quad Output Analog Audio Module
790-1002-36-1	Q Series Quad HDMI 1.3 Output Module
790-1002-22-0	Q Series Communication Module with PVW
790-1002-38-1	Q Series Dual HDMI 2.0 Output Module
790-1002-40-1	Q Series Quad 3G SDI Output Module
790-1002-41-1	Q Series Quad DVI Output Module
790-1002-45-1	Q Series Streaming Output Module
790-1002-43-1	Q Series Dual HDMI 1.3 Output Module with Dante
790-1002-47-1	Q Series Quad HDBaseT Output Module
950-0016-00-0	Q Series 300W Redundant Power Module (for 2U)
950-1004-01-0	Q Series 300W Redundant Power Module (for 4U)
950-0017-00-0	Q Series 550W Redundant Power Module (for 8U)

Xiamen RGBlink Science & Technology Co Ltd

Headquarter: Room 601A, No. 37-3 Banshang community, Building 3, Xinke Plaza, Torch Hi-Tech Industrial Development Zone, Xiamen, China

Website: www.rgblink.com | **Tel:** +86-0592-5771197 | **Fax:** +86-0592-5788216 | **E-mail:** sales@rgblink.com



©2024 RGBlink All rights reserved.