

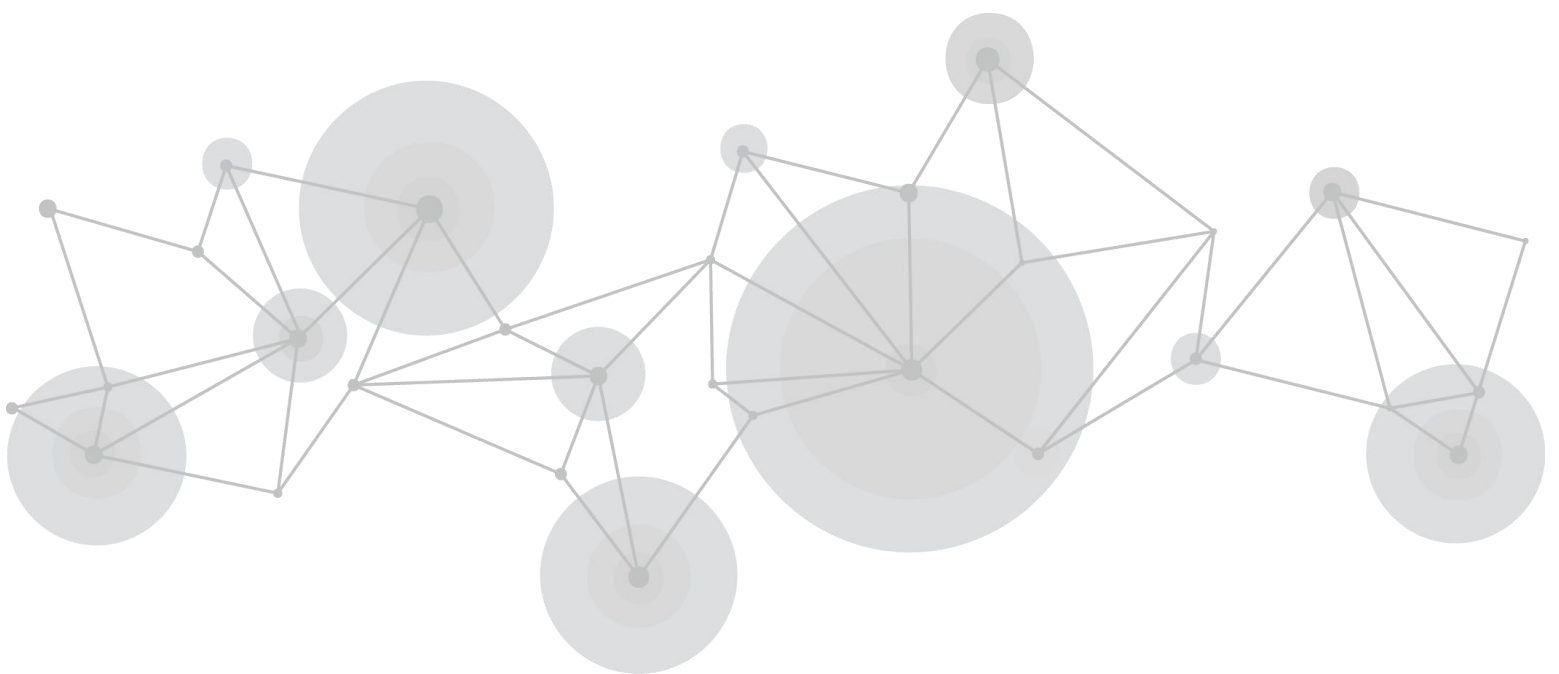

User Manual

RGBlink[®]



Content

Declarations	5
FCC/Warranty	5
Operators Safety Summary	6
Installation Safety Summary	6
Chapter 1 Your Product	8
1.1 In the Box	8
1.2 Product Overview	9
1.2.1 Key Features	10
1.2.2 Front Panel	11
1.2.3 Interface Panel	12
1.2.4 Dimension	13
Chapter 2 Install Your Product	14
2.1 Connect HDMI Input	14
2.2 Connecting HDMI Output	15
2.3 Connect Microphone and External Monitoring Devices	16
2.4 Connect USB for Recording	16
2.5 Connect Router	17
2.6 Plug in Power	17
2.7 Turn on Your mini-pro	17

Chapter 3 Use Your Product	18
3.1 Touch Screen Operation	18
3.1.1 Touch Screen Introduction	18
3.1.2 Swipe Shortcut	19
3.1.3 Preset Menu	19
3.2 Switch Source	20
3.2.1 Switch Source	20
3.2.2 Transition Effect setting	20
3.3 Switch Mode	25
3.4 PIP (Picture in Picture)	26
3.4.1 PIP Layout Setting	26
3.4.2 PIP Layer Setting	26
3.4.3 Blend	28
3.5 Save and Load Views	29
3.6 Video Output	30
3.6.1 HDMI Output	30
3.6.2 HDMI2 Output	32
3.7 Audio	33
3.7.1 MIC and LINE	34
3.7.2 MIX	34
3.7.3 AFV	35
3.8 Chroma Key	35

3.9 PTZ	36
3.9.1 PTZ Control	37
3.9.2 PTZ Preset	38
3.10 Stream	39
3.10.1 Direct Connection	40
3.10.2 Smartphone Tethering	40
3.10.3 YouTube Live	42
3.10.4 Streaming Setting	44
3.10.5 Controlling PTZ Camera During Live	45
3.11 Record	45
3.12 Settings	47
3.12.1 Language	48
3.12.2 Device Version	48
3.12.3 TAO Cloud	49
3.12.4 Input Information	51
3.12.5 IP Setting	52
3.12.6 Color Setting	52
3.12.7 Time Setting	52
3.12.8 Fan Speed	53
3.12.9 Auto PVW	53
3.12.10 T-Bar Correction	53
3.12.11 Key Test	54

3.12.12 Update	55
3.12.13 Reset	55
Chapter 4 Network Streaming	57
4.1 OBS Streaming	57
4.2 vMix Streaming	60
4.3 Facebook Streaming	62
4.4 Zoom Streaming	63
Chapter 5 Ordering Codes	64
5.1 Product Code	64
Chapter 6 Appendix	65
6.1 Specification	65
6.2 FAQ	66
6.3 Upgrade	68
6.4 Terms & Definitions	70
6.5 Revision History	75
Chapter 7 Support	76

Thank you for choosing our product!

This User Manual is designed to show you how to use this product quickly and make use of all the features. Please read all directions and instructions carefully before using this product.

Declarations

FCC/Warranty

Federal Communications Commission (FCC) Statement

This equipment has been tested and found to comply with the limits for a class A digital device, pursuant to Part 15 of the FCC rules. These limits are designed to provide reasonable protection against harmful interference when the equipment is operated in a commercial environment. This equipment generates, uses, and can radiate radio frequency energy and, if not installed and used in accordance with the instruction manual, may cause harmful interference to radio communications. Operation of this equipment in a residential area may cause harmful interference, in which case the user will be responsible for correcting any interference.

Guarantee and Compensation

RGBlink provides a guarantee relating to perfect manufacturing as part of the legally stipulated terms of guarantee. On receipt, the purchaser must immediately inspect all delivered goods for damage incurred during transport, as well as for material and manufacturing faults. RGBlink must be informed immediately in writing of any complains.

The period of guarantee begins on the date of transfer of risks, in the case of special systems and software on the date of commissioning, at latest 30 days after the transfer of risks. In the event of justified notice of compliant, RGBlink can repair the fault or provide a replacement at its own discretion within an appropriate period. If this measure proves to be impossible or unsuccessful, the purchaser can demand a reduction in the purchase price or cancellation of the contract. All other claims, in particular those relating to compensation for direct or indirect damage, and also damage attributed to the operation of software as well as to other service provided by RGBlink, being a component of the system or independent service, will be deemed invalid provided the damage is not proven to be attributed to the absence of properties guaranteed in writing or due to the intent or gross negligence or part of RGBlink.

If the purchaser or a third party carries out modifications or repairs on goods delivered by RGBlink, or if the goods are handled incorrectly, in particular if the systems are commissioned operated incorrectly or if, after the transfer of risks, the goods are subject to influences not agreed upon in the contract, all guarantee claims of the purchaser will be rendered invalid. Not included in the guarantee coverage are system failures which are attributed to programs or special electronic circuitry provided by the purchaser, e.g. interfaces. Normal wear as well as normal maintenance are not subject to the guarantee provided by RGBlink either.

The environmental conditions as well as the servicing and maintenance regulations specified in this manual must be complied with by the customer.

Operators Safety Summary

The general safety information in this summary is for operating personnel.

Do Not Remove Covers or Panels

There are no user-serviceable parts within the unit. Removal of the top cover will expose dangerous voltages. To avoid personal injury, do not remove the top cover. Do not operate the unit without the cover installed.

Power Source

This product is intended to operate from a power source that will not apply more than 230 volts rms between the supply conductors or between both supply conductor and ground. A protective ground connection by way of grounding conductor in the power cord is essential for safe operation.

Grounding the Product

This product is grounded through the grounding conductor of the power cord. To avoid electrical shock, plug the power cord into a properly wired receptacle before connecting to the product input or output terminals. A protective-ground connection by way of the grounding conductor in the power cord is essential for safe operation.

Use the Proper Power Cord

Use only the power cord and connector specified for your product. Use only a power cord that is in good condition. Refer cord and connector changes to qualified service personnel.

Use the Proper Fuse

To avoid fire hazard, use only the fuse having identical type, voltage rating, and current rating characteristics. Refer fuse replacement to qualified service personnel.

Do Not Operate in Explosive Atmospheres

To avoid explosion, do not operate this product in an explosive atmosphere.

Installation Safety Summary

Safety Precautions

For all product installation procedures, please observe the following important safety and handling rules to avoid damage to yourself and the equipment.

To protect users from electric shock, ensure that the chassis connects to earth via the ground wire provided in the AC power Cord.

The AC Socket-outlet should be installed near the equipment and be easily accessible.

Unpacking and Inspection

Before opening product shipping box, inspect it for damage. If you find any damage, notify the

shipping carrier immediately for all claims adjustments. As you open the box, compare its contents against the packing slip. If you find any shortages, contact your sales representative. Once you have removed all the components from their packaging and checked that all the listed components are present, visually inspect the system to ensure there was no damage during shipping. If there is damage, notify the shipping carrier immediately for all claims adjustments.

Site Preparation

The environment in which you install your product should be clean, properly lit, free from static, and have adequate power, ventilation, and space for all components.

Chapter 1 Your Product

1.1 In the Box

1 x Power Adapter



1 x USB-C Cable



1 x USB-A Cable



1 x Audio Cable



Notes:

1. For computers/phones/pads without HDMI port but with USB-C interface, you can convert USB-C to HDMI.
2. Be sure that the USB-C interface shall meet the USB 3.1 standard.

1.2 Product Overview

The classic and compact "SWITCH" five-way joystick is the feature of the RGBlink mini-pro, which has adhered to a user feedback-driven product iteration since 2021, emphasizing a “responsive” design philosophy.

The third-generation live streaming switcher builds on the foundations of the first and second generations and adds an additional HDMI output without increasing the overall dimensions. This enhancement allows for simultaneous multi-screen monitoring while providing the capability for PGM Program output display and independent input selection, further enhancing display flexibility. The mini-pro retains 4 HDMI 2.0 inputs, supporting a maximum resolution of 4K@60 and backward compatibility. In terms of audio, the mini-pro has undergone a comprehensive hardware upgrade, utilizing a fully differential true balanced DAC circuit architecture that effectively improves the audio quality of both MIC and LINE inputs.

The mini-pro features a USB 3.0 output supporting various encoding formats such as YUY2 and MJPEG. When connected to a computer, it can be automatically recognized without additional drivers, which facilitates streaming on platforms like Facebook, YouTube, ZOOM, Tik Tok etc. mini-pro features a 2.1-inch full-color IPS touch screen with an icon-based touch menu management system, paired with the classic five-way joystick and toggle, allowing for smoother and more convenient control during layer movement, aspect ratio adjustments, PTZ control, Chroma Keying, and PIP operations.

Additionally, the mini-pro introduces robust network streaming capabilities, allowing for simultaneous streaming to up to 4 platforms via RTMP(s), and supports RGBlink TAO cloud integration control, enabling simultaneous streaming to up to 32 platforms.

Beyond live streaming and control functionalities, the mini-pro supports a solid-state drive recording interface with a capacity of up to 2TB, enabling 24/7 live streaming with synchronized recording. It also maintains the capability for quick preset and mode recalls, enhancing the synchronized

operation of multiple control devices, assisting you in achieving more diverse scene display applications.

In terms of software, the mini-pro is compatible with Windows and macOS desktop operating systems and supports control via iOS and Android mobile devices.

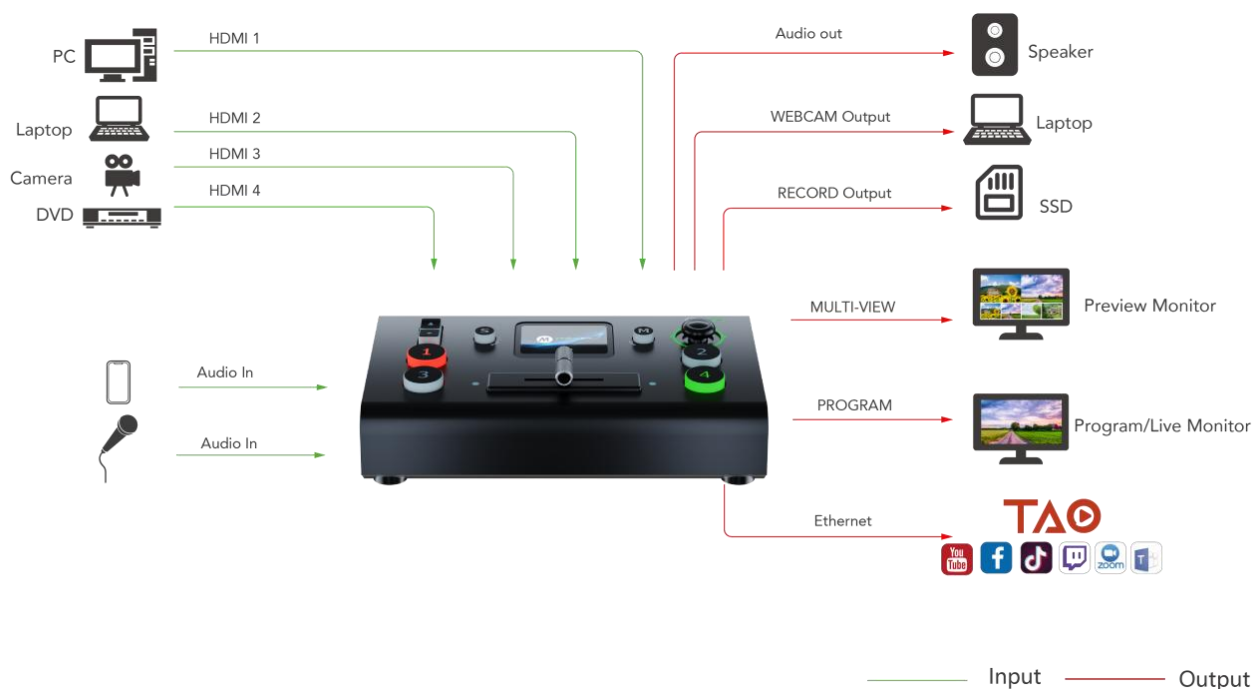

1.2.1 Key Features

- mini and convenient to carry
- Built-in LCD for video preview and touch menu operation
- Quad HDMI 2.0 inputs (HDCP 1.4 compliance), resolutions up to 4K@60
- Dual HDMI 1.3 outputs for monitoring of multi-view Preview, Program or AUX
- Mix for 4-channel HDMI embedded and 2-channel external audio
- AUTO and WIPE Switch mode available
- 15 transition effects
- USB 2.0 one-key recording in exFAT or FAT32 format with bitrate up to 16Mbps
- USB output supports YUY2 and MJPG format, which can be recognized as webcam for streaming
- Support RTMP(s) network streaming up to 4 platforms

- Save and load PTZ presets. One-click for preset recall
- 5-direction joystick and toggle for controlling PTZ camera (IP VISCA Protocol supported)
- Specify either “green” or " Blue” as the key color for Chroma Key
- Support TAO Cloud integrated control, compatible with desktop systems

1.2.2 Front Panel

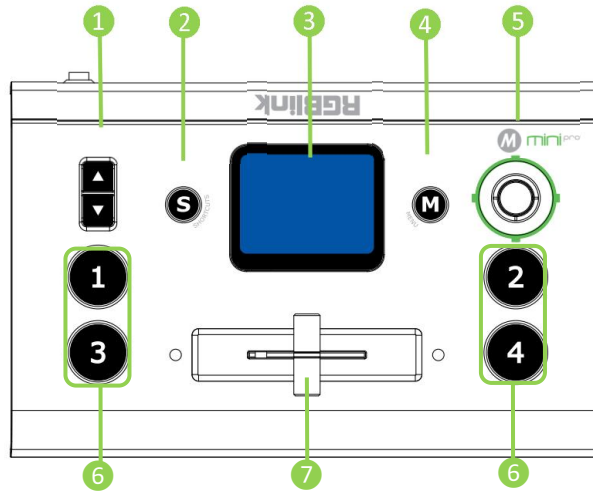

No.	Item	Description
①	Toggle	<ul style="list-style-type: none"> ● Preset Menu: Adjust Program volume. ● PIP Mode: Proportionally adjust size of sub-picture. ● PTZ Control: Zoom in and zoom out. ● IP Setting: Adjust IP values.
②	S Button	Press shortcut button to enter quick operation interface, which includes 8 Presets to load, Audio, Record on/off, Stream on/off.
③	Touch Screen	<ul style="list-style-type: none"> ● For menu operation and 4 inputs monitoring. ● PTZ Control: Monitor the screen of the currently controlled camera, and save the currently set screen by tapping it, and a call button can be formed.
④	M Button	<ul style="list-style-type: none"> ● Single Click <ul style="list-style-type: none"> ○ 4-window Monitoring Interface: Press to enter Menu Interface. ○ Menu Interface: Press to enter 4-window Monitoring Interface. ○ Others: Press to exit.

		<ul style="list-style-type: none"> ● Long Press ○ 4-window Monitoring Interface: Press to lock control panel. ○ Others: Press to 4-window Monitoring Interface.
⑤	5-Direction Joystick	<ul style="list-style-type: none"> ● Move Up/Down/Left/Right ○ PTZ Control: Set pan, tilt and zoom for PTZ camera. ○ Layer Adjustment: Position adjustment for sub-layer.
⑥	①② ③④	<ul style="list-style-type: none"> ● Button Unlit: no input signal. ● Button Lit White: unselected input signal. ● Button Blinked Green: Preview out. ● Button Lit Red: Program out.
⑦	T-Bar	Preview and Program views can be transitioned by pushing T-Bar.

1.2.3 Interface Panel

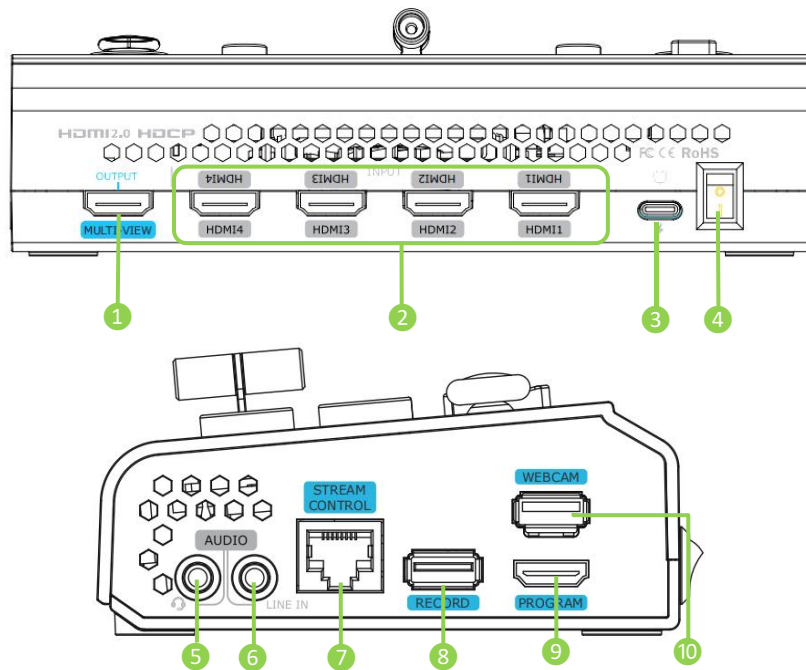

No.	Item	Description
①	MULTI-VIEW Output	Default as multi-view output, can set as Program, HDMI 1~4 or AUX output.
②	HDMI 1~4 Inputs	<ul style="list-style-type: none"> ● Four HDMI input channels for connecting HDMI sources.

		<ul style="list-style-type: none"> ● 4K resolution and downward compatible with all resolution.
③	USB-C Power Socket	PD protocol, 12V/2.5A.
④	Power Switch	Rocker switch to power on or off the device.
⑤	MIC In & Audio Out	Support one passive MIC input and one audio output via 2-in-1 audio split cable.
⑥	Line In	Active audio input, connect to mobile phone, computer or audio console.
⑦	Ethernet Port	<ul style="list-style-type: none"> ● Control: Connected to PTZ camera for direct control. ● Stream: Access to internet for live streaming.
⑧	RECORD	Connect to SSD or U disk to record audio and video from Program.
⑨	PROGRAM Output	Default to output real-time scene, which can be set as Multi-view Preview or Test Pattern.
⑩	WEBCAM	USB Stream Output: Capture signal via third party streaming software and push to live broadcasting websites.

1.2.4 Dimension

Following is the dimension of mini-pro for your reference:

180.6mm × 112.7mm × 53.0mm

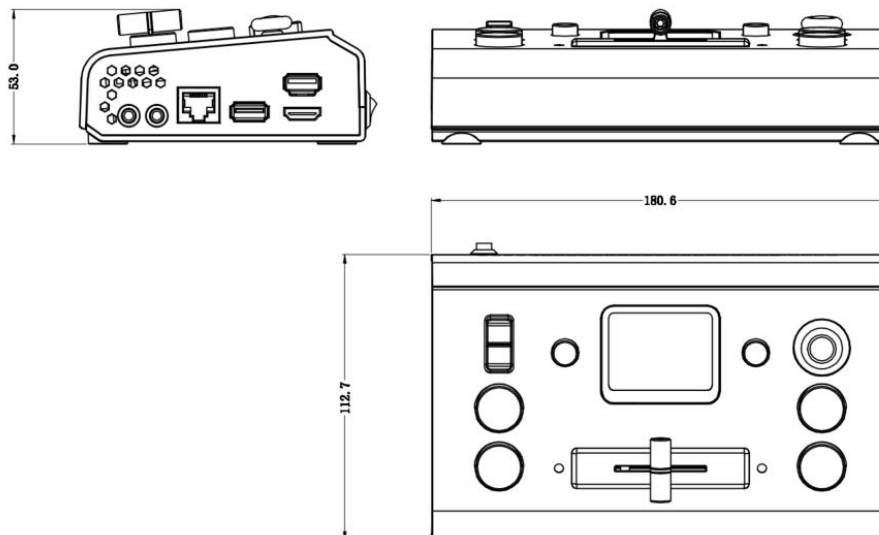

Chapter 2 Install Your Product

2.1 Connect HDMI Input

Users can use any camera, computer or other HDMI device as the input source of the mini-pro. mini-pro supports up to 4 sources of different formats and resolutions at the same time via 4 HDMI ports, and **4 HDMI inputs support up to 4K@60Hz**. If users are using interlaced signal, mini-pro supports de-interlace function.

Users can see the input views on the mini-pro screen when there is active signal plug in. Connect mini-pro to a monitor with HDMI output interface to see Preview views and output resolutions.

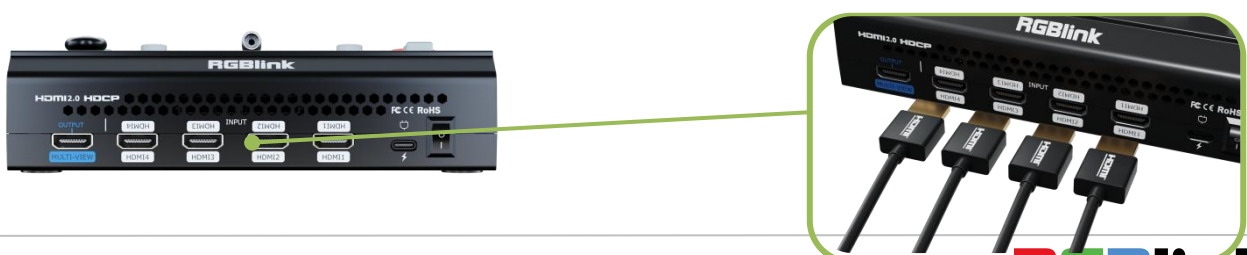



Warning:

The HDMI cable is not included in the mini-pro package and needs to be purchased separately. Some camcorders use a mini HDMI port, you need to buy a mini HDMI-HDMI cable separately when you use these camcorders.

2.2 Connecting HDMI Output

Users can use HDMI cables to connect MULTI-VIEW and PROGRAM output interfaces to a monitor with an HDMI input interface so as to check Preview and Program views in real time.



The default output of MULTI-VIEW port is multi-screen Preview view, so the user can see the audio and video conditions of all input signal sources, check current status of each function of mini-pro and see the Preview and current PGM (Program) output.



In addition to supporting multi-screen monitoring, HDMI output also supports single screen display of any one of the four inputs. Switch between Preview and Program in "Video Output".

HDMI output supports resolution setting . Press "M" Button, tap Format on the Video Output menu to select the output resolution. HDMI output supports resolution up to 1080p60.

2.3 Connect Microphone and External Monitoring Devices

On the right panel of mini-pro, there is a 3.5mm standard microphone interface which can be directly connect to the microphone or wireless MIC, or LINE output from the external audio console to do audio mixing of multiple external audio inputs.

The mini-pro supports 3.5mm analog audio and 4-channel HDMI digital audio for multi-channel simultaneous mix in to make sure sound of the computer and the sound of the MIC can be output at the same time.

You can use external speakers or headphones to monitor main output audio signal in real time.

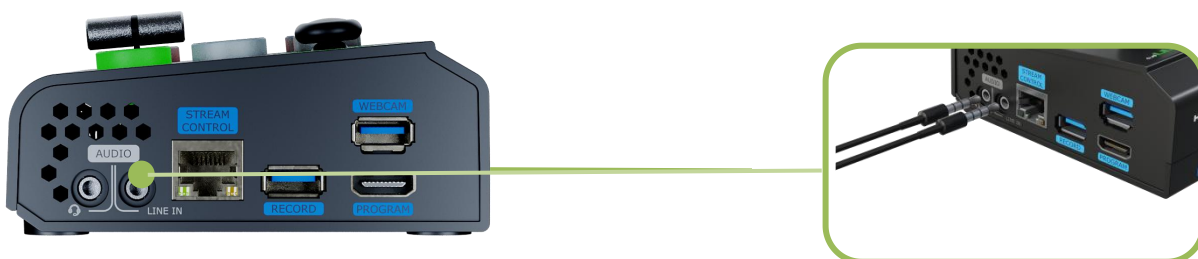

2.4 Connect USB for Recording

Connect the USB 3.0 port labeled as WEBCAM on mini-pro to computer by USB 3.0 cable (blue) and computer will capture mini-pro USB output as a webcam source, which can be pushed to Facebook, YouTube, Zoom, Twitter and other streaming media platform.

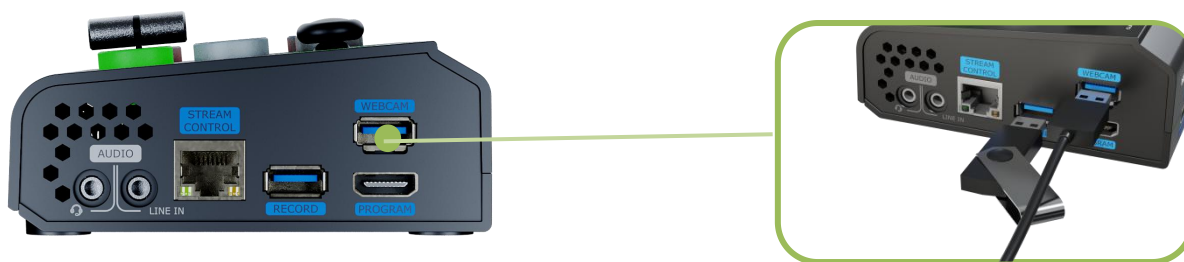

Notes:

1. If your computer only has a USB-C port, you can use a USB-A to USB-C cable to transmit the webcam signal. Please note that the USB-C cable you choose needs to support data transmission. The signal is recognized in Windows and MAC system as “RGBlink USB 3.0 Capture”.
2. For SSD, please check if it needs extra power supply.
3. For dual-channel streaming, or use UVC output/recording simultaneously, the touch screen may

get sluggish.

2.5 Connect Router

Connect router and mini-pro with CAT6 cable. Push "M" Button to enter MENU, click SETTINGS and then IP Setting, Turn off DHCP to set IP address of mini-pro. When connecting mini-pro and the router, the IP address of mini-pro must be in the same LAN as the router.

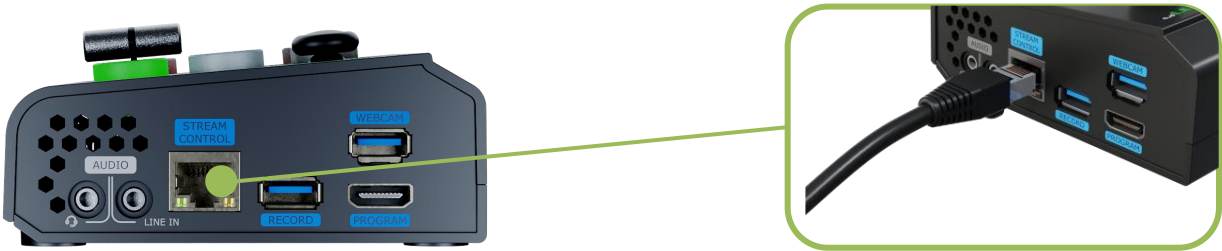

2.6 Plug in Power

RGBlink mini-pro is packaged with a PD power adapter (power cable included) , check the power supply standard used in your country or region before power connection.



Connect mini-pro to power plug by the link cable



Warning: The Power Supply included with mini-pro is the recommended power supply to use with the device. Power supply should meet the following requirements:

1. Support PD "Fast Charge" capability.
2. USB-C port which can be inserted in either direction.
3. The power supply is rated for a minimum of 20W.

2.7 Turn on Your mini-pro

After mini-pro is connected to power supply, push the Switch on the rear panel, the device will show supply standard used in your country or region before power connection.

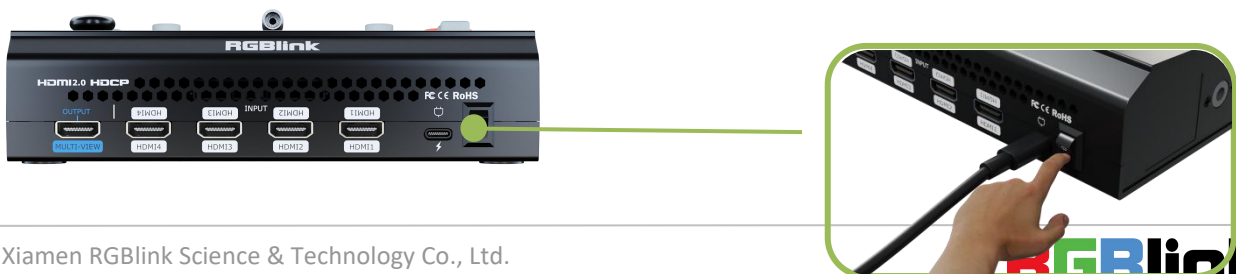



Chapter 3 Use Your Product

Complete the above steps, the user can use mini-pro to do the following.

3.1 Touch Screen Operation

3.1.1 Touch Screen Introduction

There is a 2-inch touch screen on mini-pro operation board, through which most operations can be done, so let's introduce this touch screen first.

Before introducing the operation of the touch screen, we need to introduce the "M" Button, the MENU and back key. Push the button and the 2-inch LCD screen will quickly return to the main menu interface.



As shown in the figure below, the UI style on the touch screen is similar to current smart phone operating interface. The first-level menu is in icon. You can quickly enter the corresponding function management interface by tapping corresponding icon.

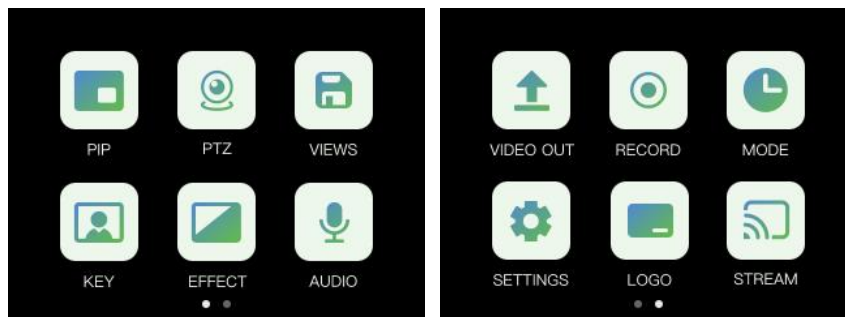

3.1.2 Swipe Shortcut

Similarly, the mini-pro's touch screen also has some simple **swipe shortcut** functions:

- Swipe from top to bottom: Enter the Preset Load Menu (same as the "S" Button).

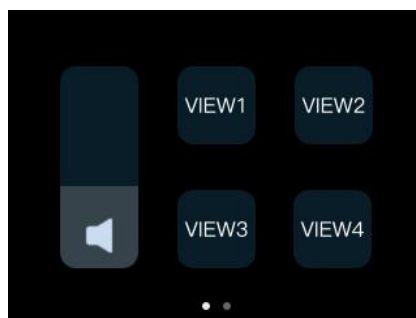

- Swipe from right to left or left to right: Switch menu interface.
- When entering an operation item, such as adjusting the transition time, slide the time bar or push the toggle on the operation board.

3.1.3 Preset Menu

In the preset menu (by pressing the "S" Button or swiping from the top to the bottom of the screen), the icons on the LCD screen default to the dark off state.

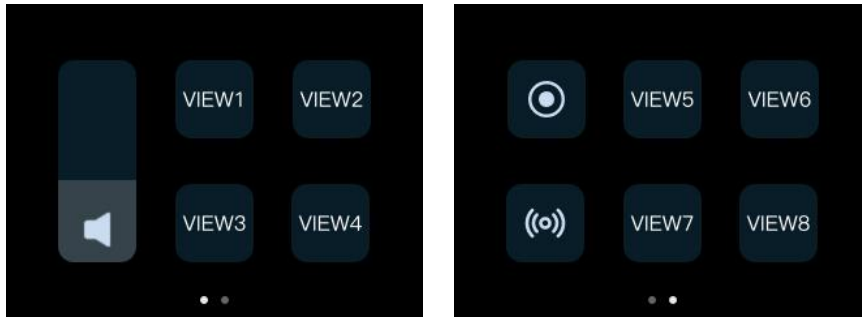

Tap to turn the icon to bright color so as to get it selected and open preset (View), volume adjustment switch, Record switch, Stream switch, etc.

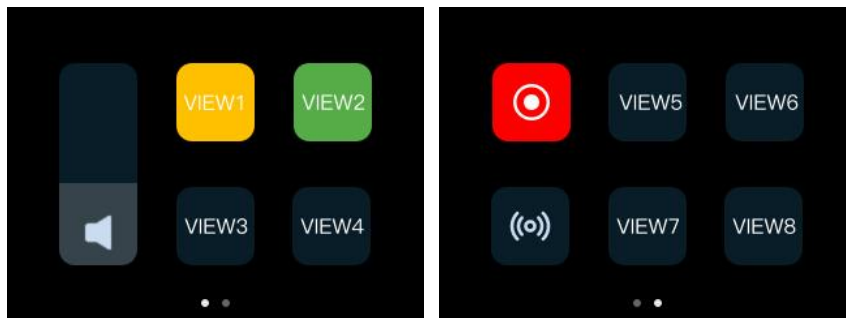

3.2 Switch Source

3.2.1 Switch Source

The buttons ①②③④ on the operation board corresponds to the 4 HDMI inputs.

When four signal source plug in, the lights on the signal source buttons will appear in four states:

- **Steady green:** The signal is recognized and no operation is performed;
- **Flashing green:** The currently selected signal is ready to be switched;
- **Steady red:** The current signal is in Program output;
- **Unlit:** No signal source is connected or the resolution of the signal source connected is not accepted.

3.2.2 Transition Effect setting

mini-pro provides 15 transition effects for dynamic views switching. Users can select effects and set transition duration according to different situations.



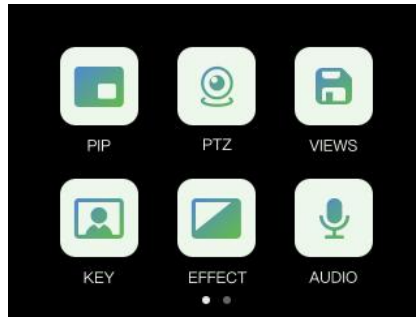







1. If you want to use more transition effects, tap "EFFECT" icon to enter transition effects selection interface, where fade in, fade out and other effects can be selected.







2. What follows are the 15 transition effects:



3. You can refer to the following table and illustration.

	Cut
	Fade
	Iris Box
	Wipe to Right
	Wipe to Bottom
	Wipe to Bottom Right
	Iris Cross
	Wipe to Left
	Wipe to Top
	Center Split
	Center Split Vertical

	Cross Inwards
	Blinds Vertical
	Box Inwards
	Iris Round

-  **CUT:** The Picture 1 switches to Picture 2 instantly with no transition effect.



-  **FADE:** FADE is a transition from Picture 1 to Picture 2 and two pictures are blended together during switching process.

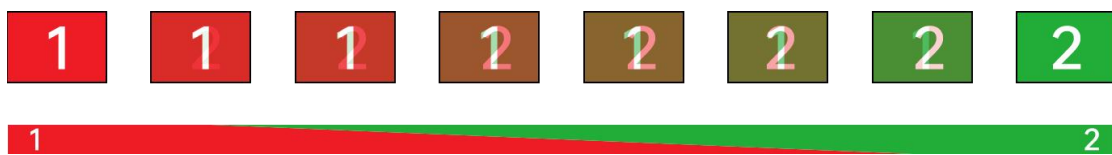

-  **Iris Round:** Iris Round refers to replacing Picture 1 by Picture 2 and is achieved by using a circle pattern growing from the center and progressing outward.



-  **Iris Cross:** Iris Cross refers to replacing Picture 1 by Picture 2 and is achieved by using a cross pattern growing from the center and progressing outward.

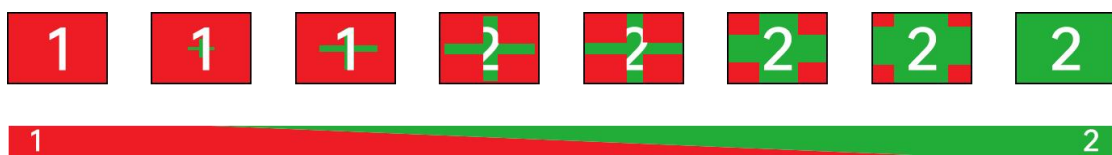

-  **Cross Inwards:** Cross Inwards refers to replacing Picture 1 by Picture 2 and is achieved by using a

cross pattern closing in from the edge towards center.

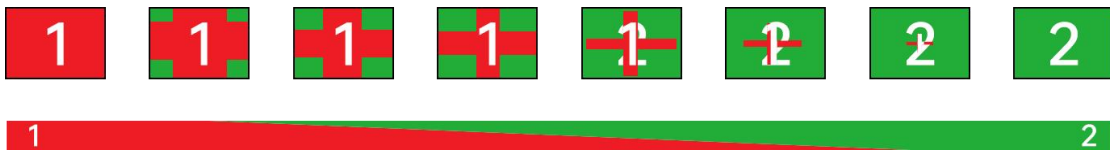

- **Iris Box**: Iris Box refers to replacing Picture 1 by Picture 2 and is achieved by using a box pattern growing from the center and progressing outward.

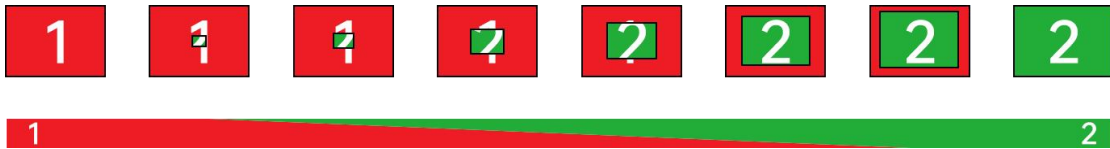

- **Box Inwards**: Box Inwards refers to replacing Picture 1 by Picture 2 and is achieved by using a box pattern closing in from the edge towards center.

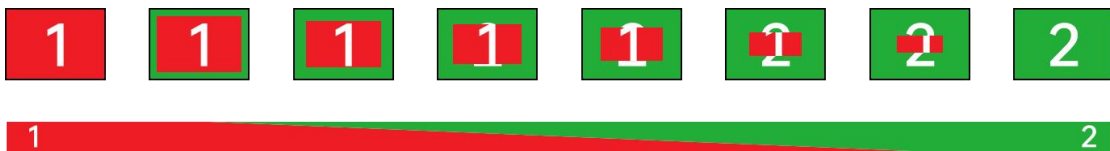

- **Wipe to Top**: The Picture 1 is unchanged, and the Picture 2 is gradually wiped in to replace Picture 1 from the upward direction.

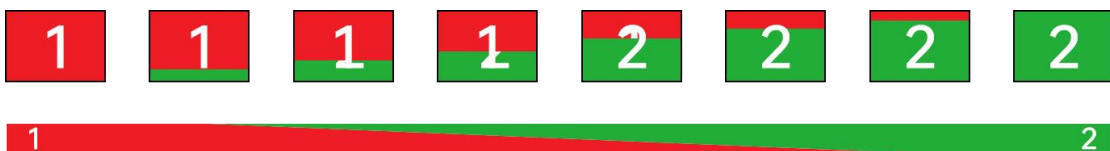

- **Wipe to Bottom**: The Picture 1 is unchanged, and the Picture 2 is gradually wiped in to replace Picture 1 from the downward direction.

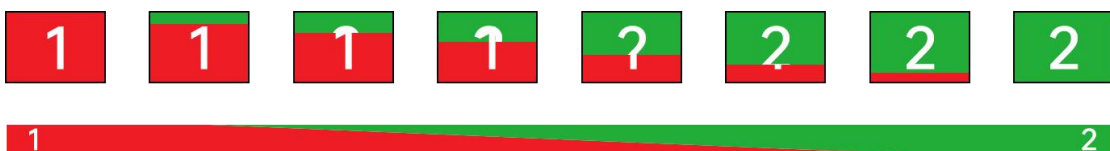

- **Wipe to Right**: The Picture 1 is unchanged, and the Picture 2 is gradually wiped in to replace Picture 1 from the rightward direction.

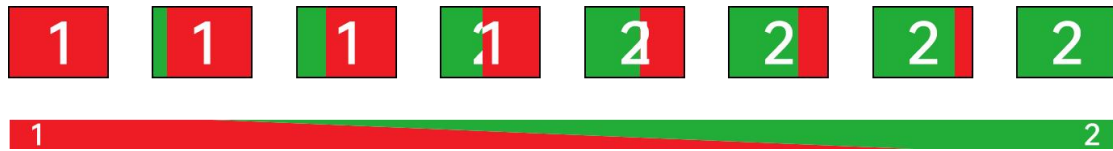

- 
Wipe to Left: The Picture 1 is unchanged, and the Picture 2 is gradually wiped in to replace Picture 1 from the leftward direction.



- 
Wipe to Bottom Right: The Picture 1 is unchanged, and the Picture 2 is gradually wiped in to replace Picture 1 from the diagonal direction.

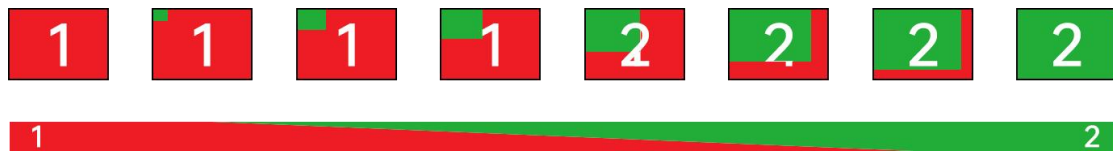

- 
Center Split Horizontal: The Picture 1 is unchanged, and the Picture 2 grows from the center and extends horizontally.

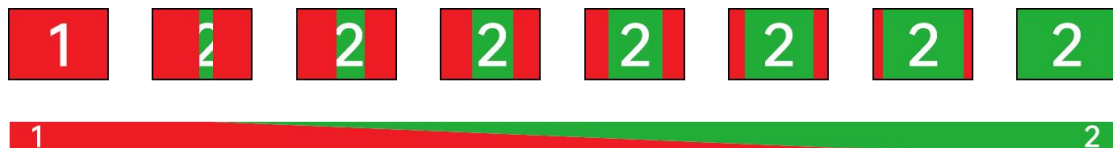

- 
Center Split Vertical: The Picture 1 is unchanged, and the Picture 2 grows from the center and extends vertically.

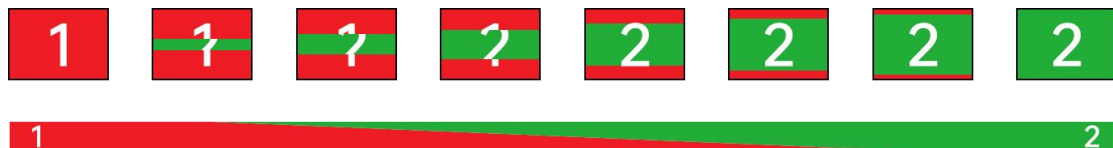

- 
Blinds Vertical: Blinds Vertical refers to an animation that imitates opening or closing blinds from a vertical direction. The Picture 1 is unchanged, and the Picture 2 which is divided into bars extend vertically.

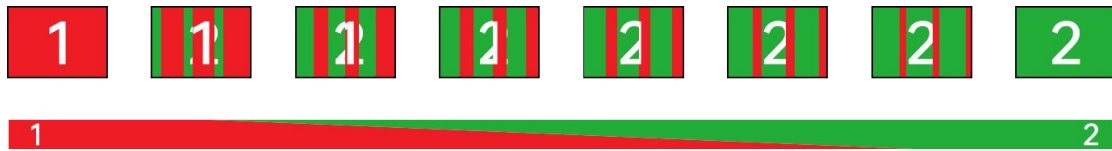

3.3 Switch Mode

mini-pro provides two switch modes: fast mode and T-bar mode. mini-pro defaults to T-bar mode and users can switch modes as needed.

1. Tap “MODE” to enter the switch mode and switch duration setting interface.

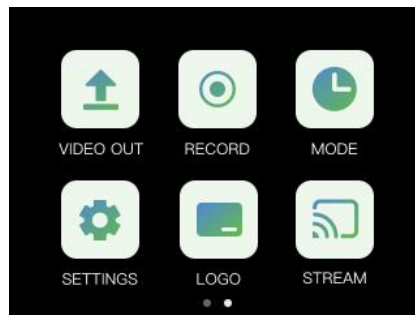

2. mini-pro supports fast mode. Slide the bar to set the switch duration. After the setting, the signal sources will be switched according to the configured transition effect and switch duration.

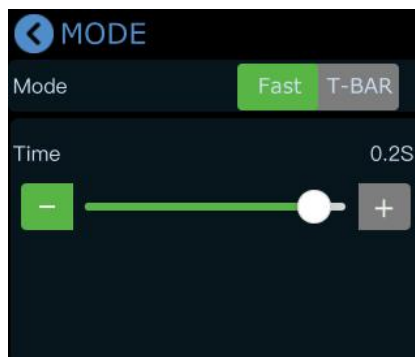

3. mini-pro supports T-BAR mode. On some important occasions, you may need to preview and preset the next scene to ensure the accuracy and stability of the screen. After enabling the T-BAR mode, you can preview and edit the next scene on the PVW window. After the editing, slide the T-BAR to switch between Preview and Program.

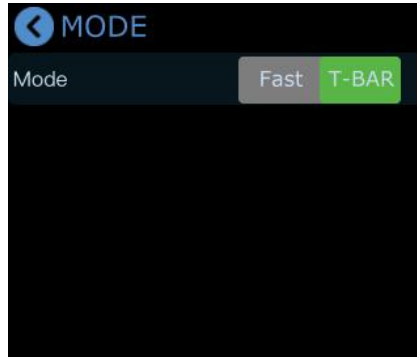

3.4 PIP (Picture in Picture)

mini-pro defaults to single-screen switching. PIP layout allows multiple windows to be displayed simultaneously on a single screen, offering users a perfect platform to check multiple video contents at the same time. If you need to use PIP, push "M" Button to return to the main menu, then find "PIP", and tap the icon to enter the PIP setting interface.



3.4.1 PIP Layout Setting

Layout options for picture-in-picture are shown in the below. Click the arrow on the right to enter layout interface and choose the layout needed.



3.4.2 PIP Layer Setting

1. Tap "Adjust" on the PIP setting interface for layer adjustments.



2. Main/sub layer selection: The user can tap A/B icon to select main layer or sub-layer and then press ①②③④ buttons for signal source selection.

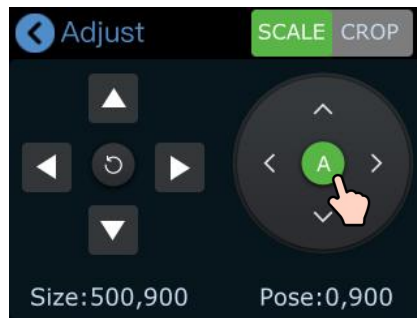

3. If detailed adjustment is required, return to "PIP" menu, adjust the size and position via the up/down/left/right keys, as shown below. Or you can use toggle for size adjustment and joystick for position adjustment.



4. 9:16 scale adjustment: the layer defaults to display at full size on the PVW and PGM window. For some occasions requiring mobile phone scale, mini-pro provides 9:16 scale. Tap “9:16” on the setting interface to change the scale and tap full to restore to full size.

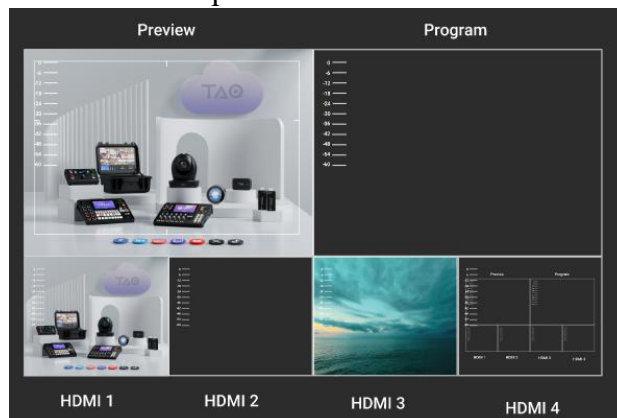

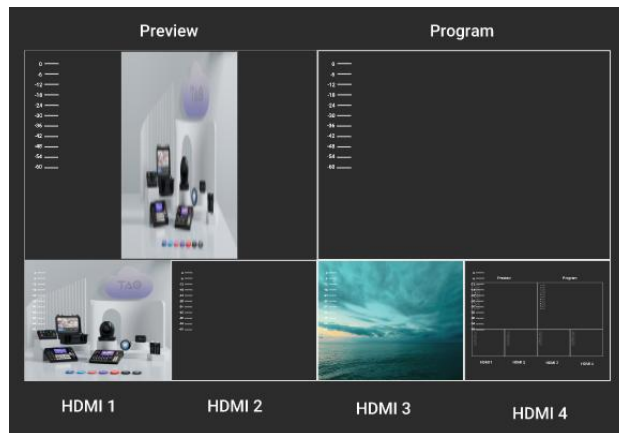

5. The crop setting interface is the same as the scale setting interface. Please refer to the function descriptions mentioned above.



3.4.3 Blend

If you want to achieve such an effect that images of two input signals can be blended with a softening effect around their edges, it is recommended to use **Blend** in mini-pro.



1. Click "Blend" in PIP menu to enter the following interface.



2. You can choose to enable the function and then configure parameters.

3. You can choose Left or Right Blend Mode. Tap   icon to adjust width and location as required.

The default Width value is 700. The larger the width value is set, the softer the edge, and the better the blending effect.

The Location is used to control the blending range. The larger the location value, the wider the blending area.

Following is the illustration of Blend.

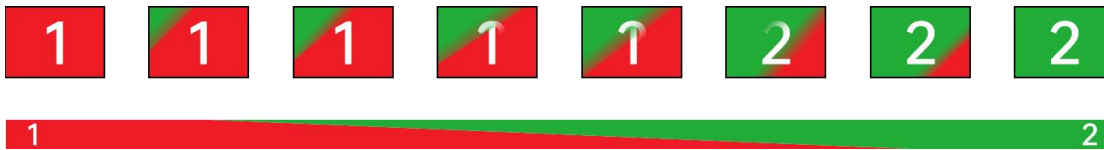

Save the above settings to the View 1~8 to realize fast call.

3.5 Save and Load Views

mini-pro save preset to View in real time. If you want to quickly load current preset next time, just save it to corresponding View. The View will save all the currently set parameters including PIP layout, Chroma Key setting, PTZ presets, therefore when you need to load any preset, just push corresponding View button in Shortcut interface.

1. After setting the effect, tap the "M" Button and find the "VIEWS".



2. By tapping the icon VIEW , you can save the preset to the corresponding View 1-8.

• **Yellow Icon:** view that being used

- **Green Icon:** saved views
- **Grey Icon:** blank view



3. Push "S" Button to enter the Shortcut menu where there are buttons of View 1~8 which can loaded directly.

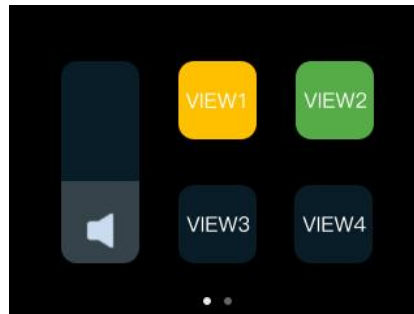

4. After loading a view, if PIP layout needs to change, users can select main screen or sub screen by tapping the center of the right side on the “Adjust” interface. After selecting sub screen or main screen, select input source for them by pushing the ①②③④ signal source buttons, adjust sub screen position by moving joystick. All the setting is saved to in real time to make sure it can be used next time.

5. If you want the modified preset to be loaded from the View, you need to re-save it to the current View or a new View. Please repeat the above operations.

3.6 Video Output

Now forget about inconvenient port function switching, mini-pro has directly upgraded it to two independent PROGRAM and MULTI-VIEW ports, making the live-streaming monitoring more efficient and intuitive.

3.6.1 HDMI Output

HDMI output defaults multi-screen preview, which can be switched to PGM Program or 1~4 inputs.

1. Push "M" Button and find "VIDEO OUTPUT" to set parameters for the HDMI output.

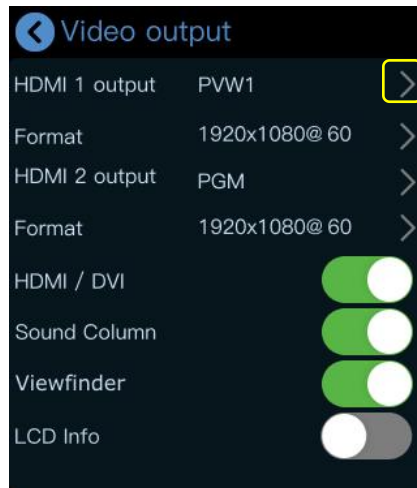

2. Users can select the resolution of HDMI2 as needed.



3. HDMI/DVI is turned on by default for connecting multiple display devices simultaneously. For example, DVI is generally used to adapt LED control cards (sending cards) and displays with DVI input interfaces, while HDMI is generally used to adapt displays with HDMI input interfaces.

4. Push "M" Button again when the touch screen is in main menu interface and touch screen will

enter 4-screen input source preview.

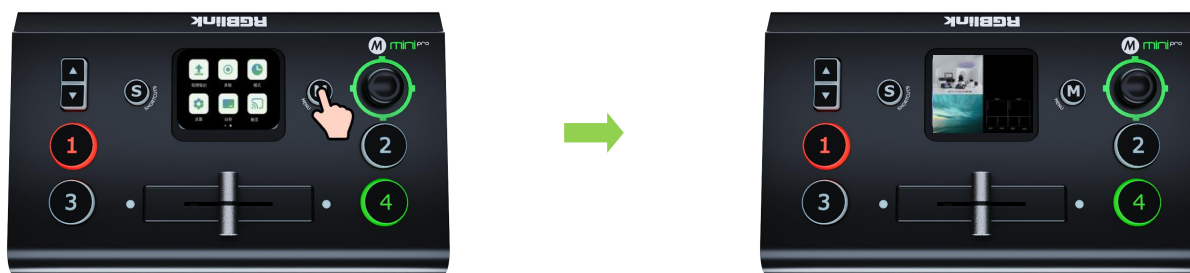

5. Turn on "Viewfinder", you can see a white rectangle in the Preview as shown in the picture, helping users frame the camera view.

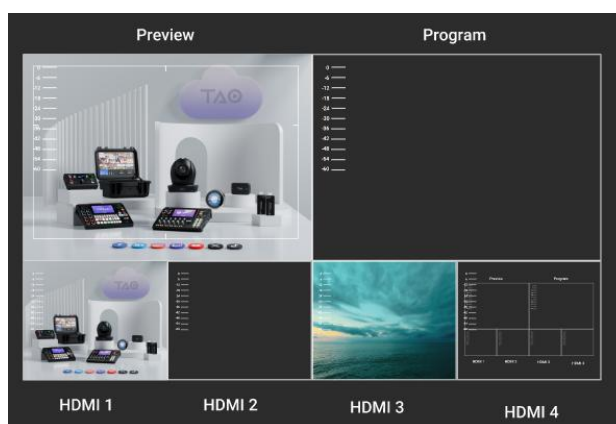

The "LCD info" LCD display setting, which controls whether the 2x2 video preview is "simple" or as "standard (Preview)", turn on "LCD Info" to check the resolution of four inputs as shown in the picture below:

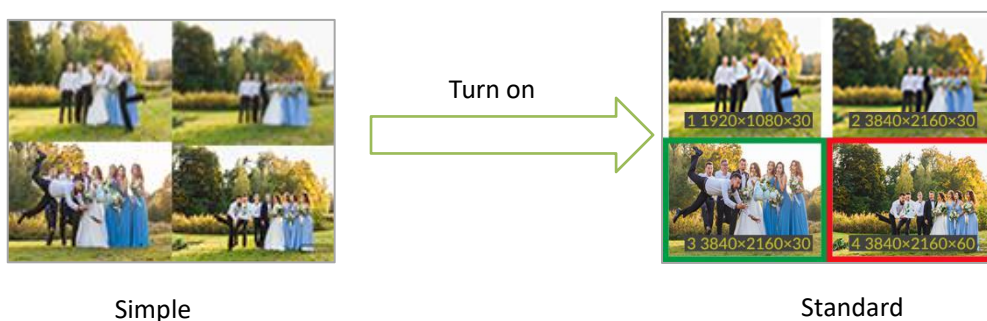

3.6.2 HDMI2 Output

HDMI2 defaults to be PGM Program and can be changed to PVW multi-view Preview or TP (Test Pattern).

1. Push "M" Button to return main menu and tap "Video Output".

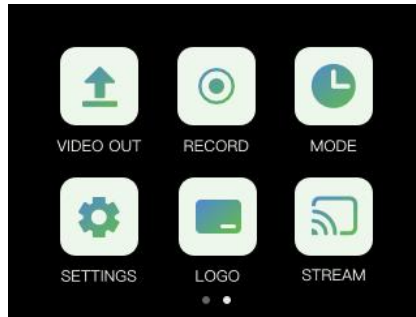

2. It is default to be PGM and tap “>” on the right to change to PVW or TP. Choose format for the output resolution by tapping “>” on the right.

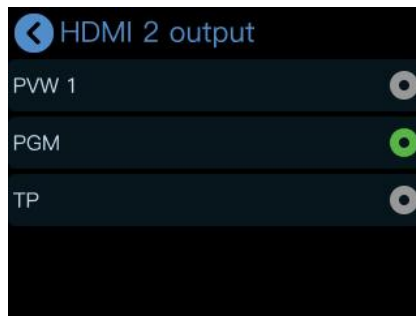

3.7 Audio

mini-pro embeds a convenient audio setting system. Users can adjust volume of every input channel. It supports mixed output of multiple channels, allowing for the perfect blend of different audio sources. Its audio-follow-video function makes the scene and sound match brilliantly, satisfying the need of content creation.

1. Tap "M" Button to return to the main menu, find and tap "AUDIO" to enter the interface.



2. The audio output can be turned on or off, and the volume can be adjusted by sliding the bar. mini-pro also supports to turn on/off or adjust volume for each audio of HDMI 1, HDMI 2, HDMI 3, HDMI 4, MIC and LINE independently.

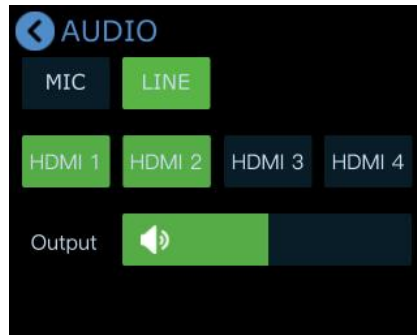

3.7.1 MIC and LINE

mini-pro features two MIC inputs, which allow users to connect it with a microphone or a line-level device.

1. Users can also click "MIC" / "LINE" interface to turn on or off MIC/LINE, adjust the audio volume level.

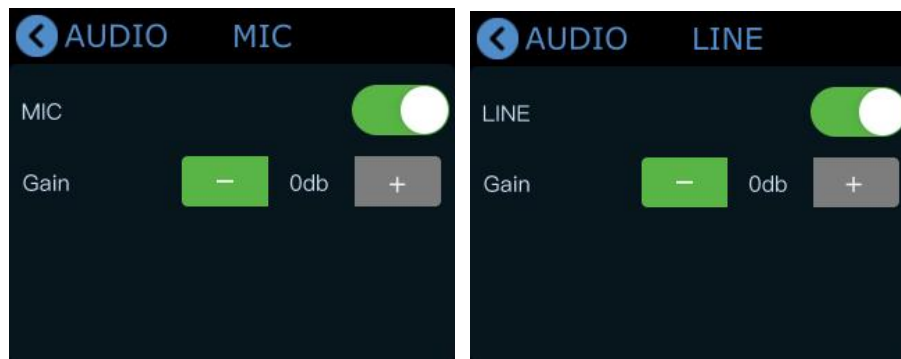

2. Tap “-” or “+” to adjust the gain. Gain: 0~100 with 10 increment

3.7.2 MIX

mini-pro supports mixed output of multiple channels. There are 6 audio channels in total as the audio source, including 4 HDMI embedded audios, 1 MIC audio input and 1 LINE audio input.

The four HDMI input ports all support embedded audio. Turn on the MIX and the audio will be permanently mixed into the Program output.

1. In "Audio" interface, you can select a specific input to configure and set by clicking on HDMI 1, HDMI 2, HDMI 3, or HDMI 4.
2. Tap “MIX” to enable the audio mixing function and the audio of the selected HDMI will be mixed to the Program output.

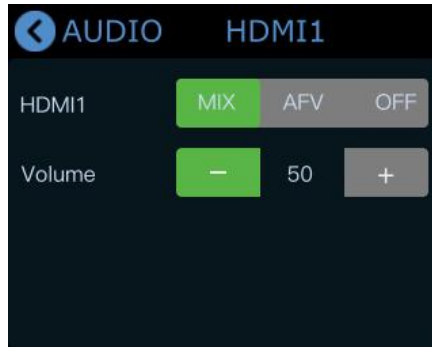

3. In "MIX", you can adjust the audio volume level.

3.7.3 AFV

Each of the 4 HDMI embedded audio channels can be set to AFV (Audio-Follow-Video) mode. When AFV is enabled, the audio will smoothly transition as the video switches. Specifically, if an HDMI audio channel is set to AFV, its audio will only play when the Program output switches to the corresponding video source of this channel.

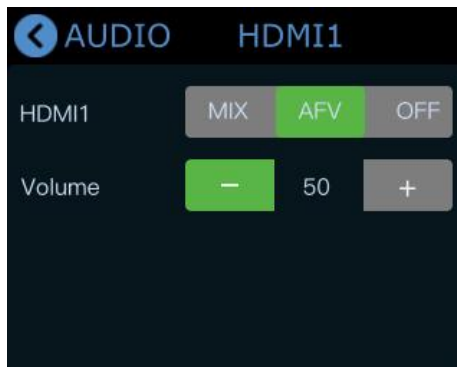

When touch screen is in Shortcut interface, the Program audio volume can be adjusted by toggle.



3.8 Chroma Key



mini-pro supports matting, the Chroma Key in the menu, removing the solid color background and overlaying it on another signal to realize the application of virtual reality. Matting can be done on the Chroma Key in the menu.

1. Push "M" Button to return to the main menu interface, find "KEY", tap this icon to enter the setting menu.

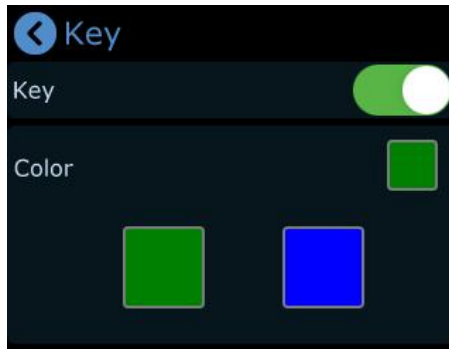

2. You can choose on or off to enable/disable the function. The sub-screen defaults to input 4, and the main screen defaults to input 1, which can both be changed to other source.



3. Select the background color which is default in green to be removed and make adjustments. Tap screen to select Max, Min and Margin, then tap   for specific adjustments. Max defaults to 1232, Min defaults to 560, Margin defaults to 602.

4. After loading the Chroma Key preset, you can use the joystick or touch screen to switch the selection of the main/sub-screen, push ①②③④ signal buttons to switch between different signals, adjust the size of the screen through the toggle, adjust the position of the screen through the joystick, and all the re-adjusted settings will be saved to the current View in real time.

5. After the Chroma Key is set, the parameters can be saved directly on the device. Next time when the the device is on no matter on the software or the touch screen itself, users can directly load the preset.

3.9 PTZ

mini-pro can control cameras supporting IP VISCA protocol. mini-pro can control the camera's lens moving horizontally and vertically, focus and zoom. Not only that, the mini-pro can also save the position and zoom information of the camera, so that you can quickly retrieve it the next time you

use it. The PTZ preset of mini-pro not only saves the parameters of the PTZ, but also includes calling the camera, that is, when the View of the PTZ is loaded, the input is switched to the camera signal source at the same time.

3.9.1 PTZ Control

1. Tap the "M" Button to return to the main menu, find the "PTZ" icon and tap it to enter the menu.



2. What follows are the PTZ setting interfaces.

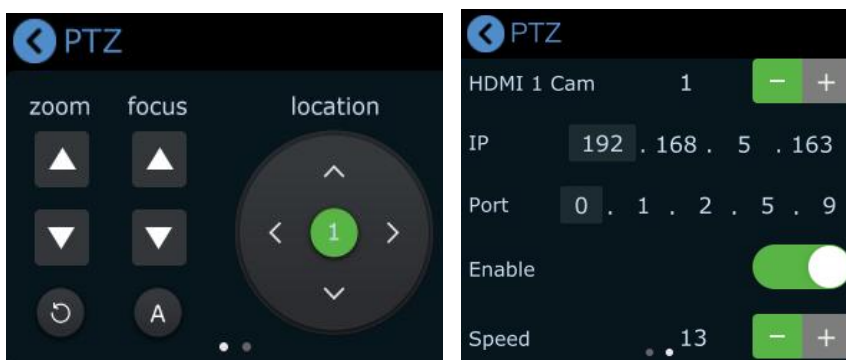

3. When setting PTZ, use the signal key ①②③④ to select the corresponding PTZ camera signal to preview. You can also select PTZ camera signals by tapping “-” and “+” on the screen.

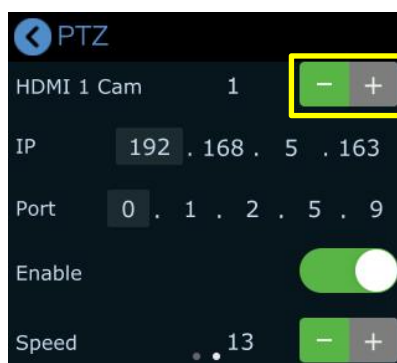

4. Please check if the port number of the controlled camera is 1259 (It's recommended to use RGBlink vue series PTZ camera). If the port number is not 1259, please enter the port number in PTZ Control interface.
5. When you want to control PTZ camera, **the IP address of mini-pro and camera should be in**

the same LAN. You can adjust the IP address in the menu below. Tap 4 segment one-by-one and then adjust IP address via toggle on the front panel. The IP address of the device can be configured on the “IP Setting” interface on the Setting section (Refer to [Section 3.12.5](#)).

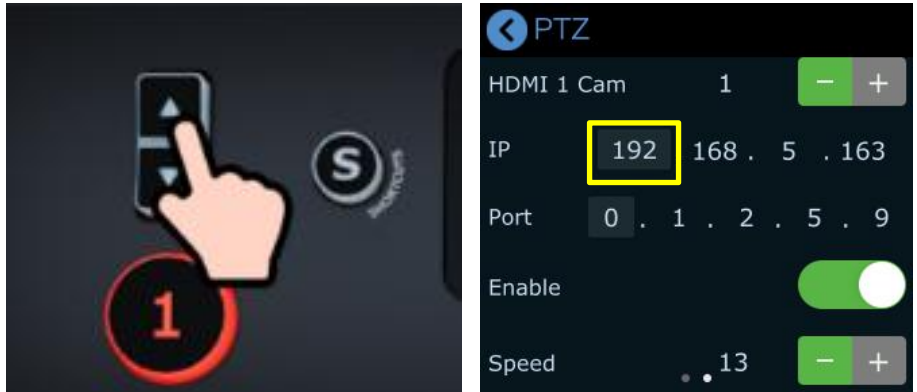

3.9.2 PTZ Preset

1. Focus: When the PTZ function is enabled, you can adjust the focus of PTZ by tapping the position icons on the screen or simply tapping the **A** to achieve automatic adjustment.

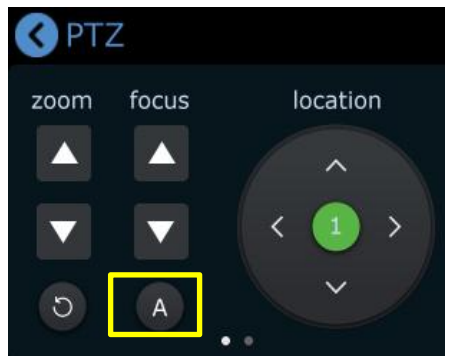

2. Rotation Speed: you can tap the speed icon on the first interface, the rotation can be adjust to 17,14,11,8,5,2. You can also adjust speed by tapping “-” and “+” on the speed area or by using the joystick.

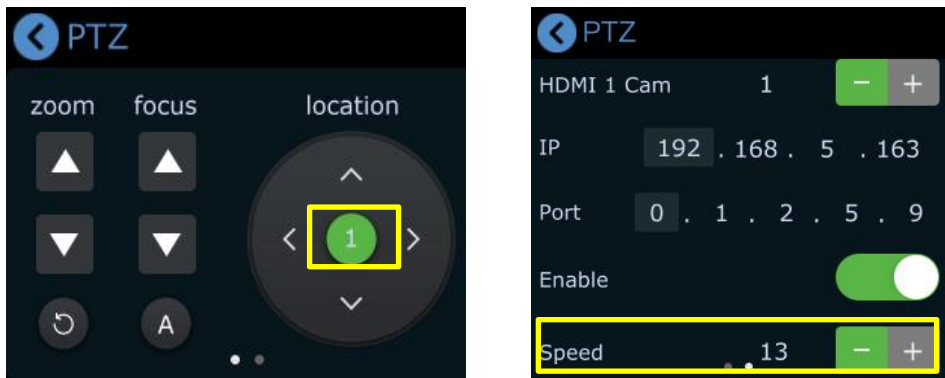

3. Reset: You can tap the  to reset the PTZ operation.



3.10 Stream

With TAO Cloud integrated directly into RGBlink devices, such as mini-pro, users can do more content production. The TAO Cloud creates an effective streaming platform, catering to the need for fast production. **mini-pro supports streaming up to 4 platforms at the same time.**

Tap the "M" Button to return to the main menu, find the "STREAM" icon and tap it to enter streaming configuration menu.

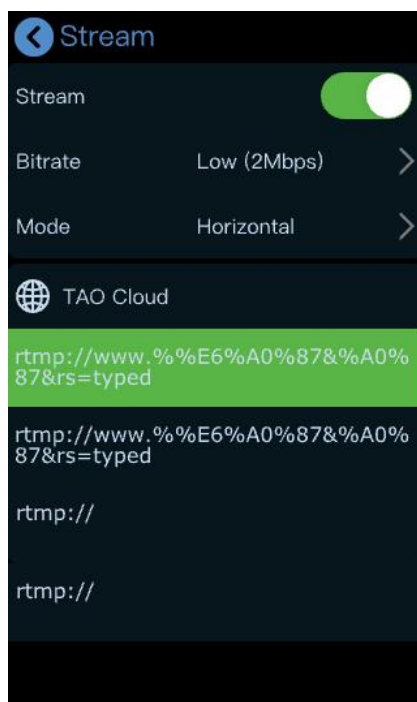

Please check network connection before enabling streaming.

You can provide network for mini-pro through **Direct Connection** or **Smartphone Tethering**.

3.10.1 Direct Connection

mini-pro switcher's Ethernet connector lets you stream directly. Connect mini-pro to the internet by plugging a network cable from the Ethernet port to an internet router or a network switch. It is recommended to use RGBlink CAT6 cable with order code as 940-0001-00-11-0.

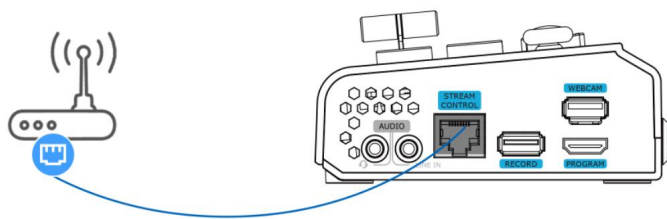

3.10.2 Smartphone Tethering

1. For iOS system, please do as follows:

1) Simply connect a standard power cord from your smartphone to the USB port labeled as WEBCAM on your mini-pro.

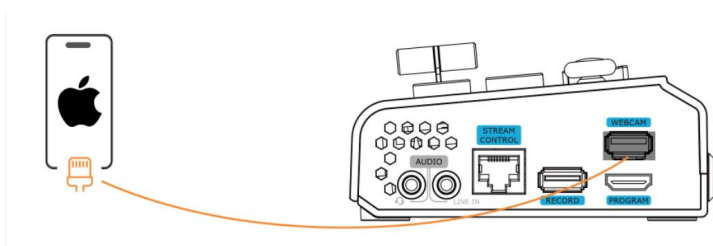

2) Then the 'Trust This Computer' alert message will appear on your device. Tap 'Trust' on your device and do as followings: Open 'Settings' > Select 'Personal Hotspot' > Enter 'WLAN Password' > Turn on 'Allow Others to Join'.

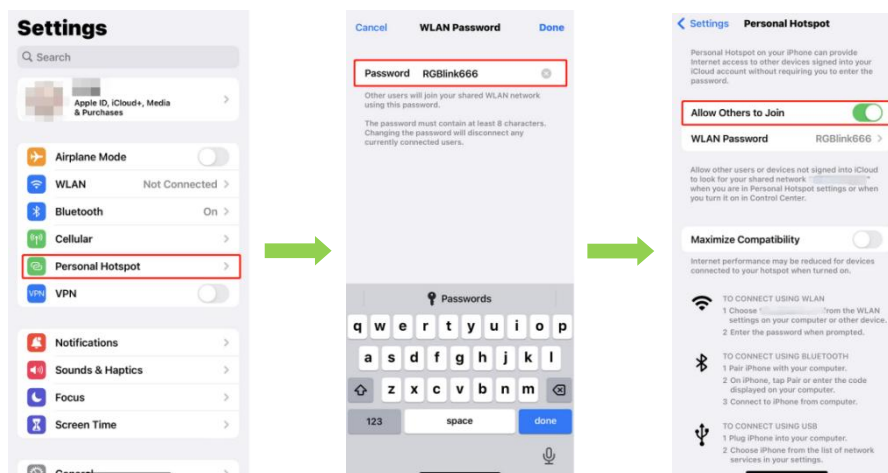

3) As shown in figures below, if the status changes from "Not Discoverable" to "Connection", it means that the mini-pro and your mobile phone have achieved network sharing.

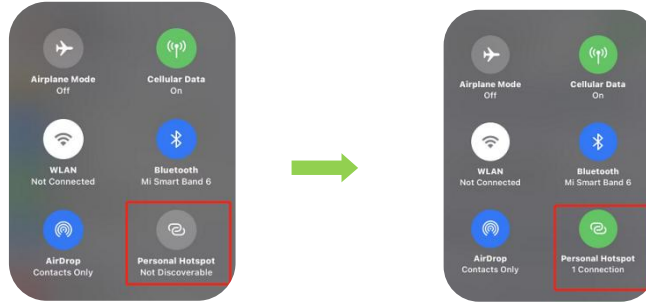

2. For Android system, please do as follows:

1) Open ‘Settings’> ‘Additional settings’> ‘Developer options’> Turn on ‘USB debugging’.

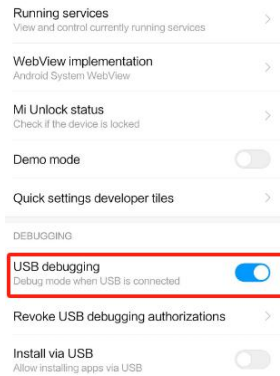

2) Simply connect a standard power cord from your smartphone to the USB port labeled as WEBCAM on your mini-pro.

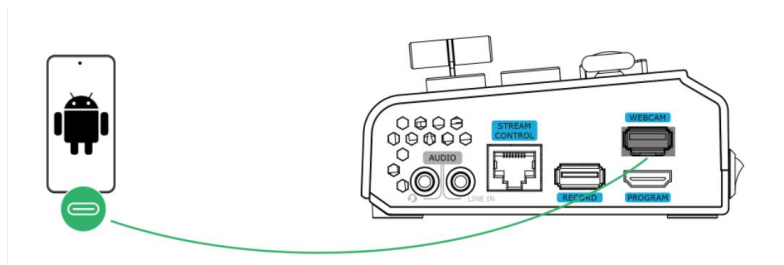

3) Open ‘Settings’ > Select ‘Mobile Network’ > ‘Personal Hotspot’ > ‘Other Sharing Mode’ > Turn on ‘Share Phone Network via USB’.

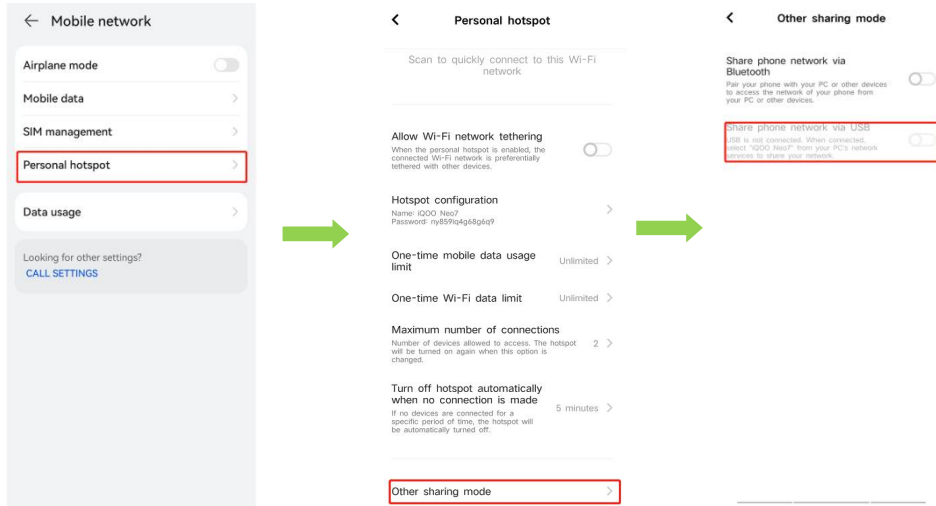

3.10.3 YouTube Live

This chapter takes YouTube Live as the example.

1. Log into your YouTube account on your computer;
2. Click the camera icon in the top right corner to create a video.

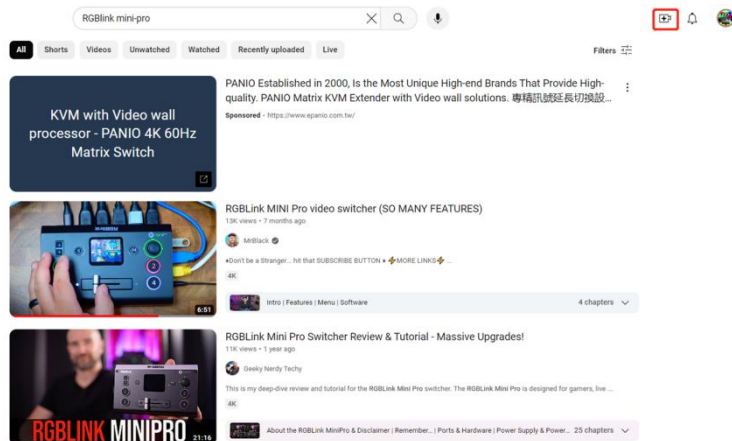

3. Select "go live".

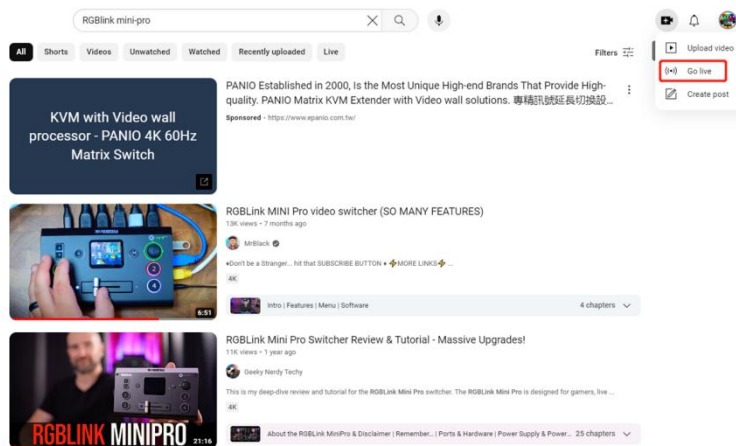

4. Type in a title and add a description in the dialogue box, click “create stream” and then copy the Stream URL and Stream Key.

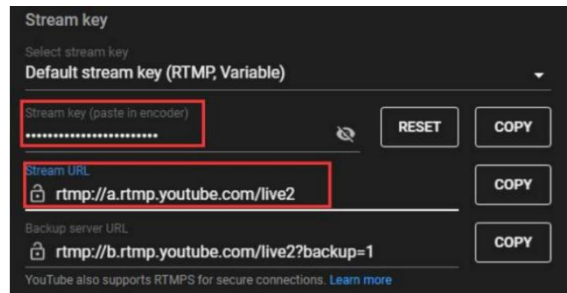

5. If mini-pro is unbound to TAO Cloud, a box will pop up to prompt the users to get a verification code. While receiving the verification code from the TAO Cloud, please make sure your network is working.

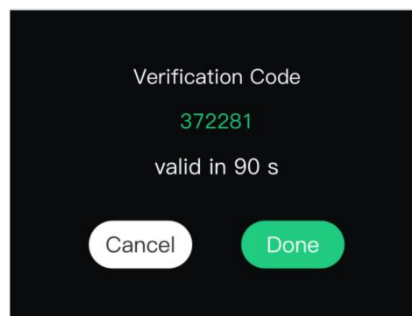

6. Log in TAO Cloud (for the log in steps. Please refer to [Section 3.12.3](#)). Copy the streaming address and streaming key into the TAO Cloud, and tap “Distribute” on the interface.

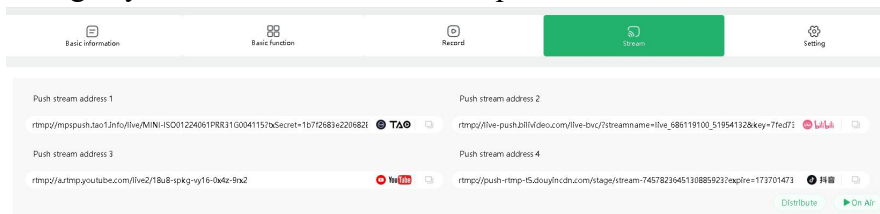

7. Turn on “Stream” on STREAM interface or tap the on air button on the SHORTCUT interface to start streaming.

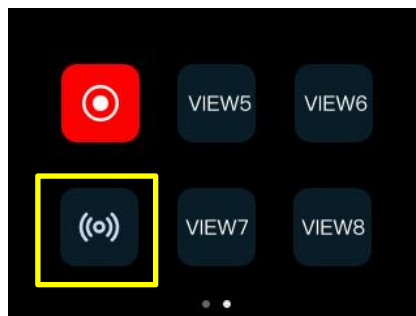
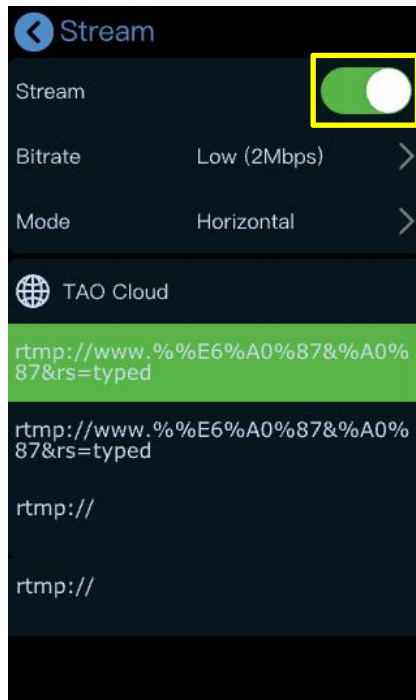

3.10.4 Streaming Setting

1. Bitrate

Users can according to the actual situation to adjust the bitrate as needed. For example, if the network speed is slow, the bitrate can be switched to a lower level.

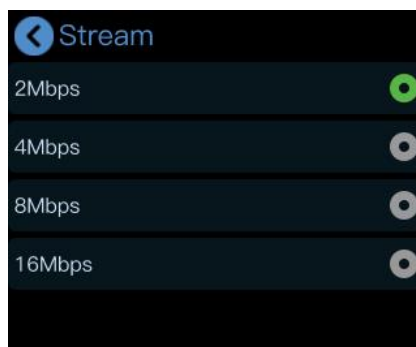

2. Screen Mode

Users can select screen mode according to the actual use.

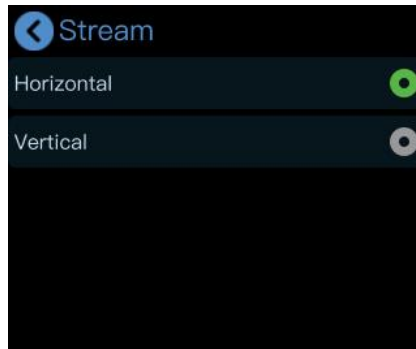

3.10.5 Controlling PTZ Camera During Live

To control PTZ camera while performing live streaming, please make sure PTZ, mini-pro and network are in the same LAN, then turn on DHCP of mini-pro in IP Setting Interface at the same time. (Turning off DHCP will not affect live streaming if the IP address does not conflict)

Click **IP Setting** on SETTING menu to configure IP address.

IP Setting:

Dynamic (IP configured by router) : Connecting mini-pro with a router with DHCP features. Turn on DHCP of mini-pro and the router, then mini-pro will capture an IP address automatically.



Static (set IP freely by yourself): Turn off DHCP to manually set IP address.



3.11 Record

The mini-pro supports recording streaming media content to an external SSD or USB storage through the USB interface labeled as RECORD. The SSD storage can reach up to 2T, and the USB

storage can support up to 64G. The supported formats include FAT32 and exFAT. The recorded video will be sectioned after storage up to 2G with each section.



1. Insert a U disk to USB port labeled as RECORD. Before recording, format the SSD or U-disk first. The steps are as below:
2. Push "M" Button to return to the main menu, and then tap "RECORD" to enter the interface to switch on Record and view the status of the SSD.

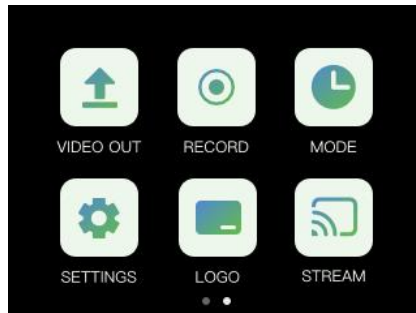

3. If no disk is inserted, recording function cannot be enabled.

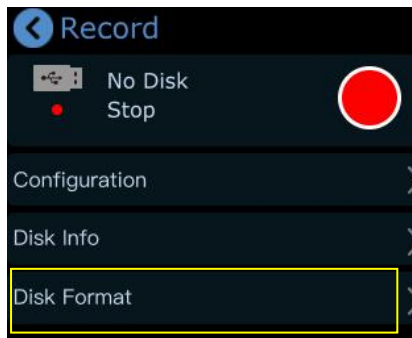

4. After USB disk is inserted, please do as follows: Set the file system to **exFAT** and the size of allocation unit to **128kb** > click **Disk Format** > tap **Yes** to format disk.

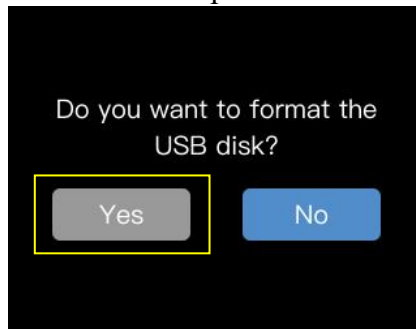

Notes: If the SSD could not be recognized when inserting into mini-pro, then use a dual USB cable to power the SSD.

5. In Recording interface, press **Configuration** to turn ON/OFF to record audio and set the quality.



6. Click **Disk Info** to check the disk information captured automatically by mini-pro.



7. Tap Recording switch in RECORD interface or SHORTCUT interface to start or stop recording, and you can check recording duration and progress.

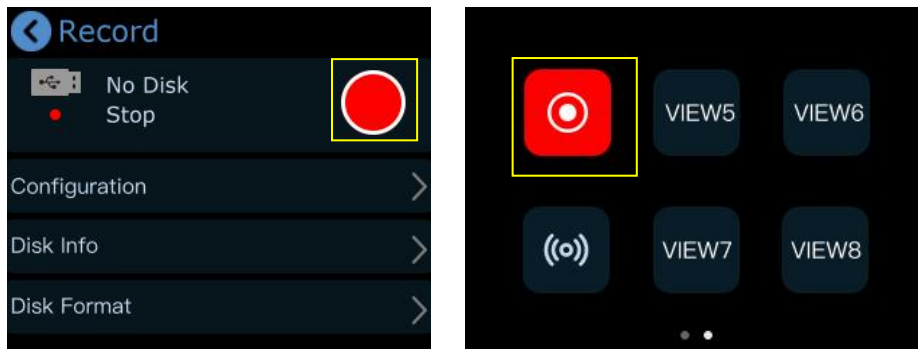

3.12 Settings

Click "SETTINGS" to enter the menu below. As shown in the figure, the Settings menu includes 12 modules: **Language, Device Version, Input Information, IP Setting, Color Setting, Time Setting, Fan Speed, Auto PVW, Reset, T-Bar Correction, Key Test, Update and Reset.**



3.12.1 Language

Click **Language** to enter the following interface. English and Chinese is optional.

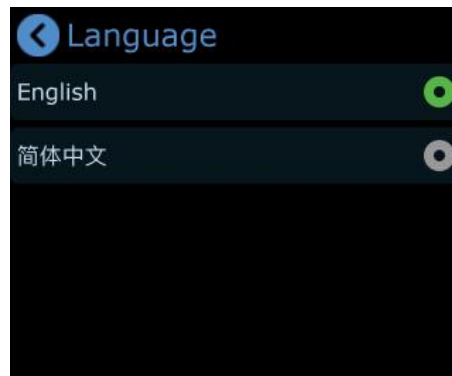

3.12.2 Device Version

Click **Device Version** to check Serial Number, MAC Address, MCU Version and Video Version.

Device Version	
SN	210510PAMIN102000034
MAC	18.30.40.3C.00.2B
MCU	0.32
VIDEO	1.43

3.12.3 TAO Cloud

With TAO Cloud integrated directly into RGBlink device, such as mini-pro, you can do more content production.

You can follow steps below to bind mini-pro to TAO Cloud.

1. Choose TAO Cloud to enter following interface and follow steps in the box to get verification code.



2. Log into TAO Cloud (available at <https://www.tao1live.com>), and use a Facebook account to log in or sign up with email.

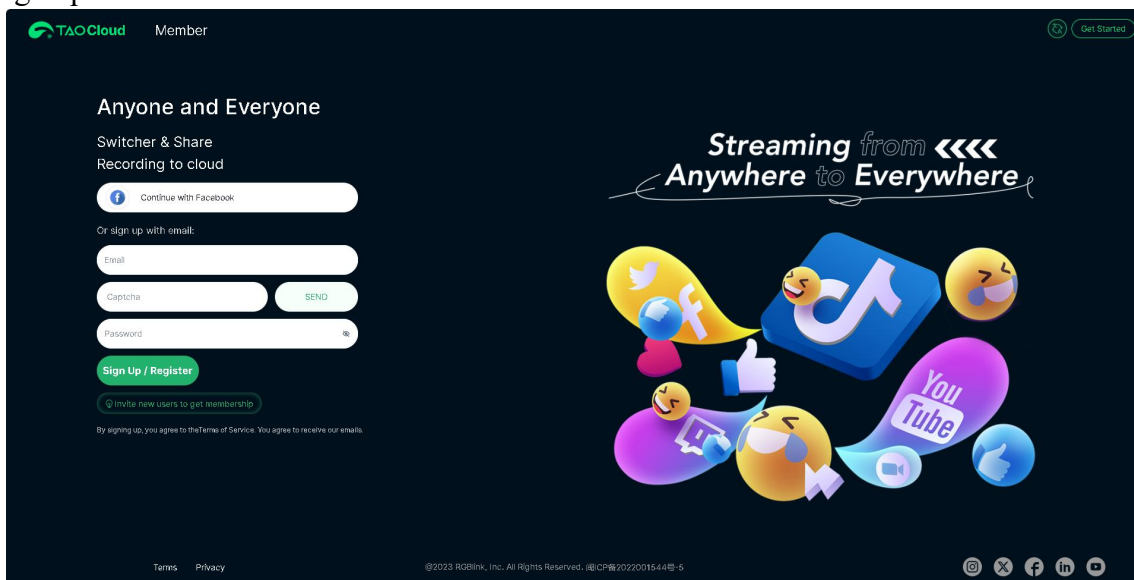

3. Enter TAO Cloud homepage. Click “All Appliances” > “Binding Devices” to enter interface as shown.

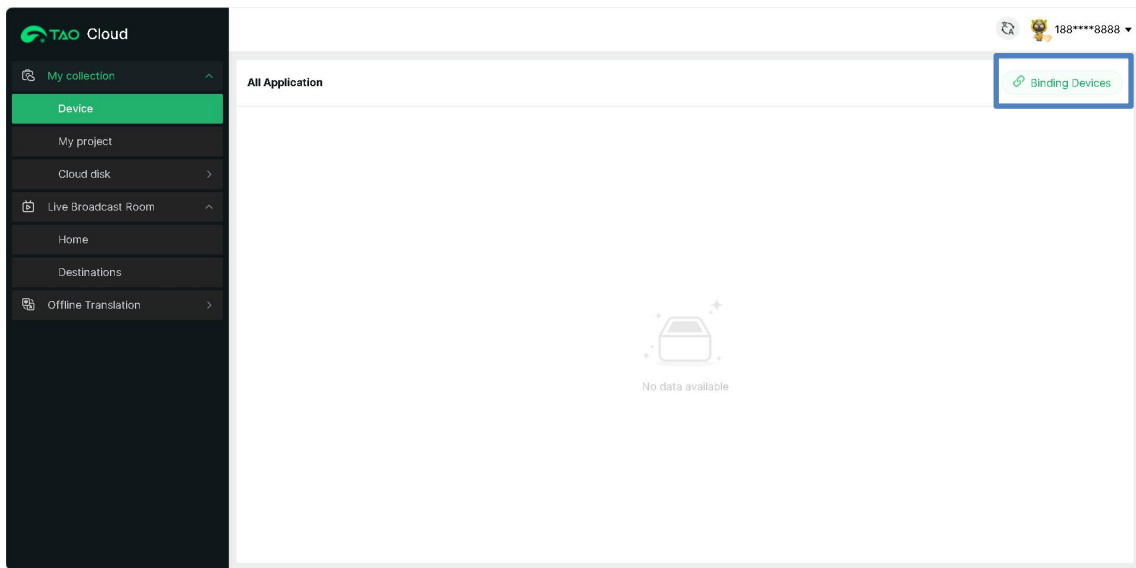

4. Enter device name (customizable) and verification code, then click “Bind” to confirm.

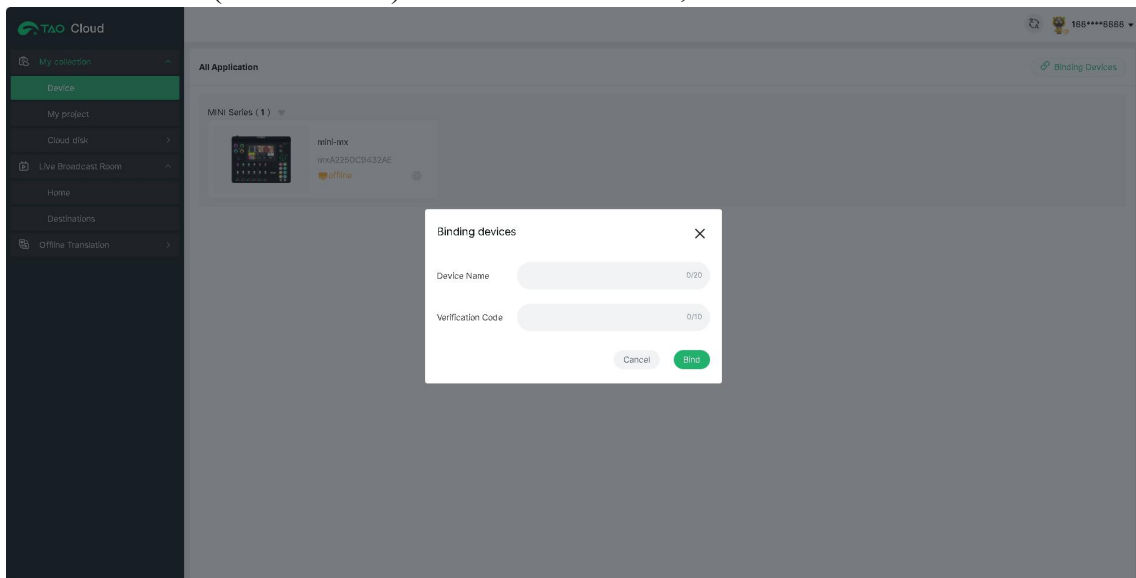

5. You can check binding status in All Appliances interface.

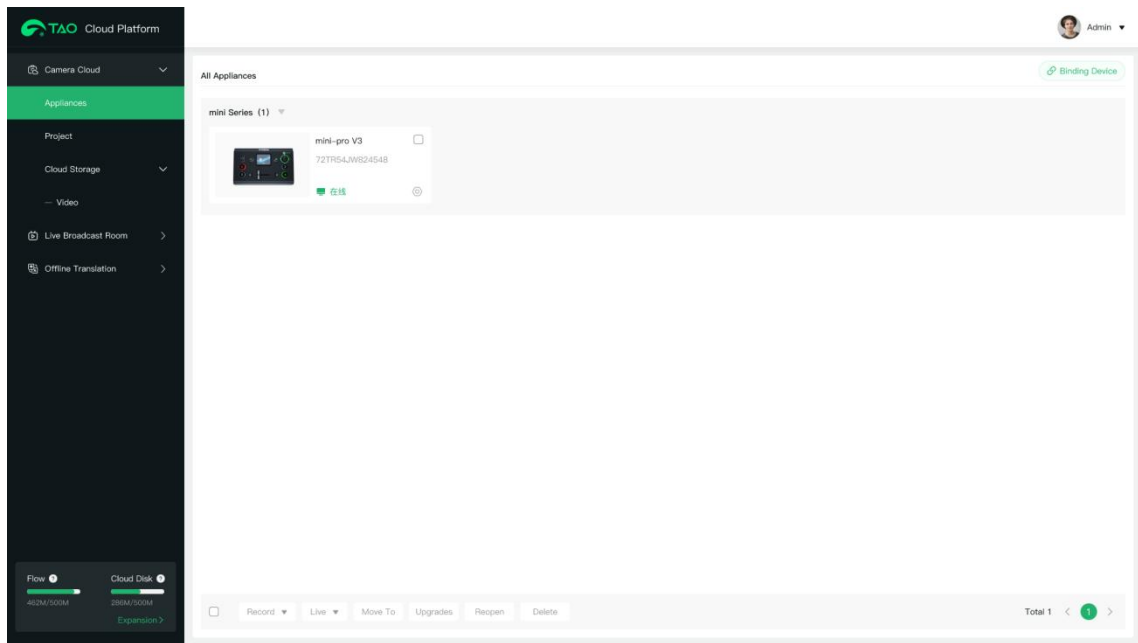

6. If you want to unbind, click "TAO Cloud" once again and then select "Rebind". Then you can choose to rebind or perform other operations.

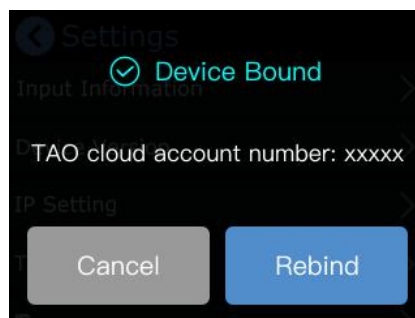

3.12.4 Input Information

Click **Input Information** to enter the following interface.

1. In this interface, users can check information of 4 HDMI inputs. If there is no HDMI input, the interface displays "No Input"; If there is an active HDMI input, the interface displays the resolution.
2. When handling interlacing signals, users can open the deinterlacing function.

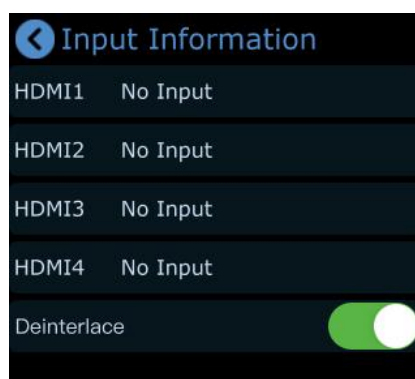

3.12.5 IP Setting

1. Click **IP Setting** to enter the following interface.

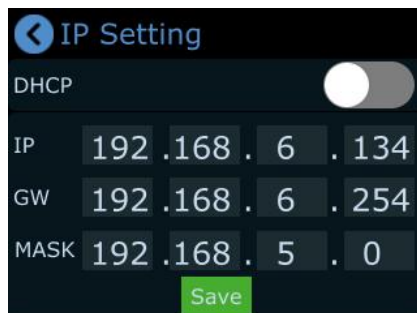

2. Turn on DHCP and mini-pro can automatically capture the IP address. If DHCP is turned off, users can manually set the IP address, net mask and gateway.

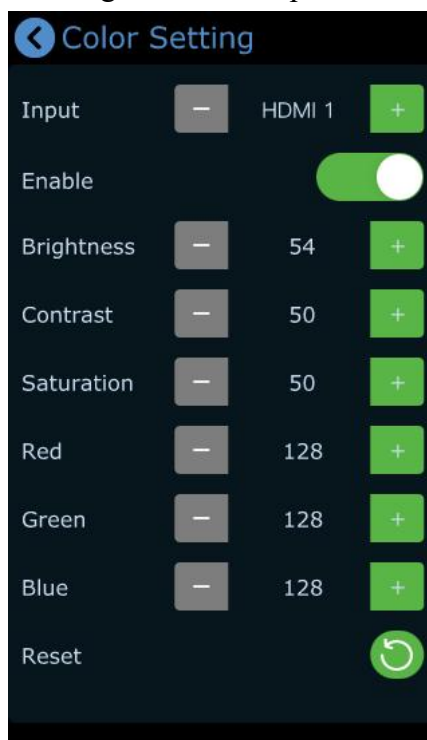

3.12.6 Color Setting

Click **Color Setting** to enter the following interface for parameter settings of 1-4 HDMI inputs.



1. The Enable switch is ON by default. Use "S" Button on the front panel to switch different options.

2. Select different HDMI inputs and then adjust Brightness, Contrast, Saturation and other

parameters by pushing toggle on the front panel or clicking   icons.

3. Restore to the default parameters by clicking  icon.

3.12.7 Time Setting

1. Click **Time Setting** to enter the following interface for date setting of recorded file.



2. Turn on power-on configuration, mini-pro will automatically pop up the interface above to remind user to set the time. The set time will be restored to the default value after powered off.

3.12.8 Fan Speed

1. Click **Fan Speed** to enter fan control interface for speed adjustment.

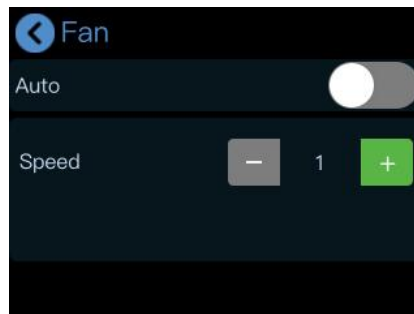



2. Four gears are available, and users can also turn on **Auto** to achieve automatic adjustment of the fan speed.

3.12.9 Auto PVW

1. Click **Auto PVW** to enter the following interface.



2. Set the time (default to be 15s) for automatic return to the default interface. Adjust automatic PVW time by pressing  . Increase or reduce 15s each time.

3.12.10 T-Bar Correction

Click **T-Bar Correction** to enter the following interface.



Follow above steps to complete T-Bar calibration:

1. Push T-Bar to right;



2. Turn on the calibration switch ;

3. Push T-Bar to left;



4. Click this icon  to turn on the calibration switch.
5. After the T-bar correction, a prompt will appear at the bottom of the interface.

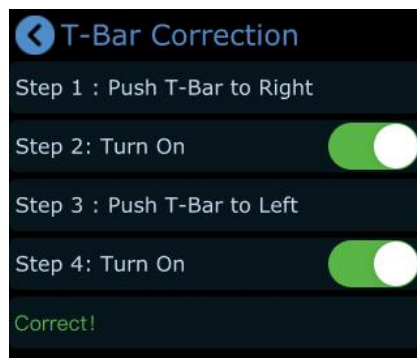

3.12.11 Key Test

1. Click **Key Test** to enter the following interface.

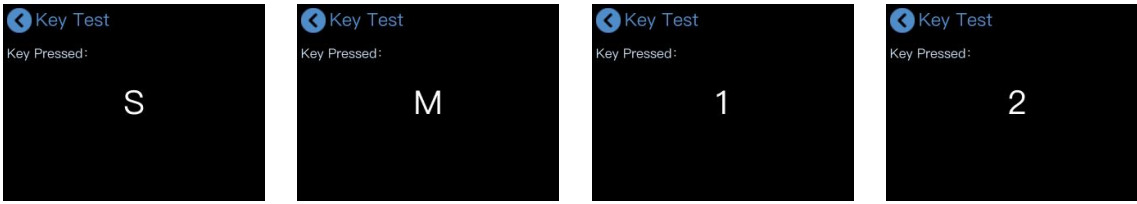

2. Press "M" Button or other keys, and make sure that the content displayed on the screen corresponds to the button you pressed to test if the button functions normally.

3.12.12 Update

Click **Update** to enter the following interface.

1. You can upgrade mini-pro by tapping "Update" (More details please refer to [6.3 Upgrade](#)).

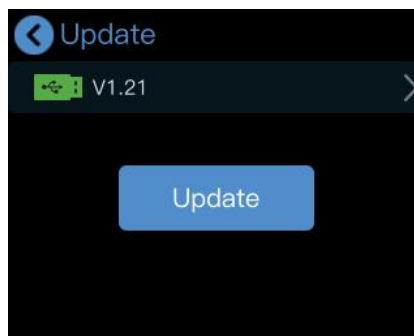

2. Please make sure the network is working when checking the device version and during the upgrade.

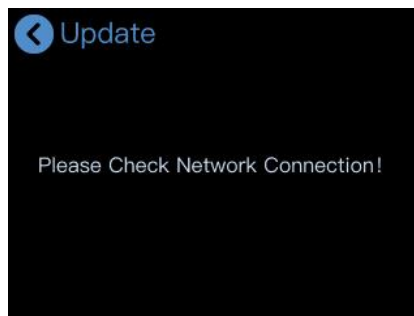

3.12.13 Reset

1. Click **Reset** to enter the following interface.



2. Click **YES** to restore to the previous settings. Please reboot the device after reset.



Chapter 4 Network Streaming

The USB port labeled as WEBCAM is for video capture, which allows users to capture videos to computer and the captured video content can be streamed to Facebook, YouTube, Zoom, Twitter and other streaming media platforms via a third-party Video Media Player software like OBS.

4.1 OBS Streaming

Video Capture

mini-pro is compatible with many third party steaming software, we recommend OBS, which is available to download on <https://obsproject.com/download>. Download the software and update to the latest version.

1. Click ”+”icon.

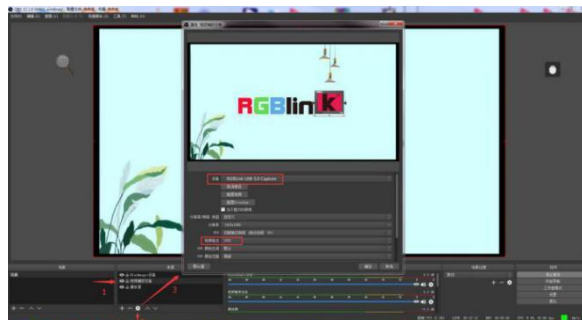

2. Choose Video Capture Device.

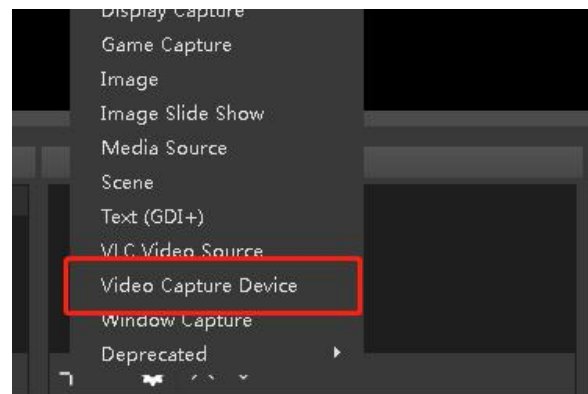

3. Choose RGBlink USB 3.0 Capture and Choose Video Format YUY2.

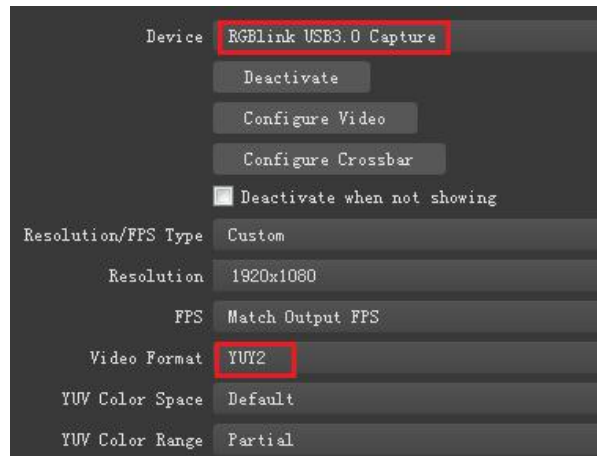

Note: If there is no video format YUY 2 after setting above, check the USB 3.0 port connection. Make sure it is linked to USB 3.0 port on PC by USB 3.0 cable. (USB 3.0 cable or port is standard in blue while USB 2.0 is in black). If the captured, change the video format to YUY2.

Audio Setting

When there is no audio playing, check the video source to see if it is set in default value and then check the audio setting on OBS.

1. Set Default for the audio source.
2. Audio setting on OBS.

Choose Audio, click Setting and choose audio device (Mic/Auxiliary Audio Device).

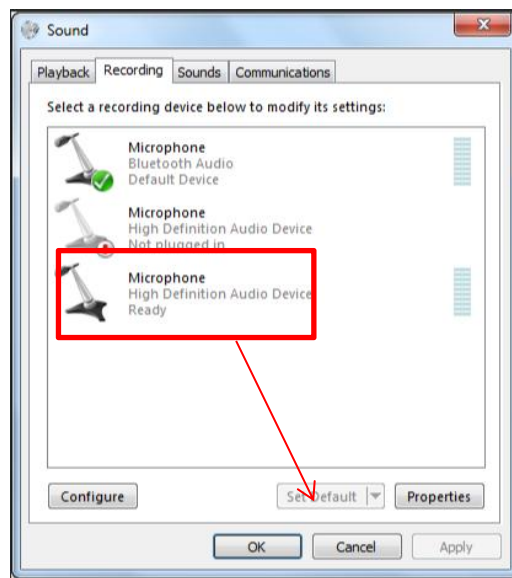

Synchronize Video with External Audio

When the video itself doesn't have embedded audio and need insert external audio. Here are the steps.



1. Set the audio source: Setting→Audio→Mic/Auxiliary Audio Devices.

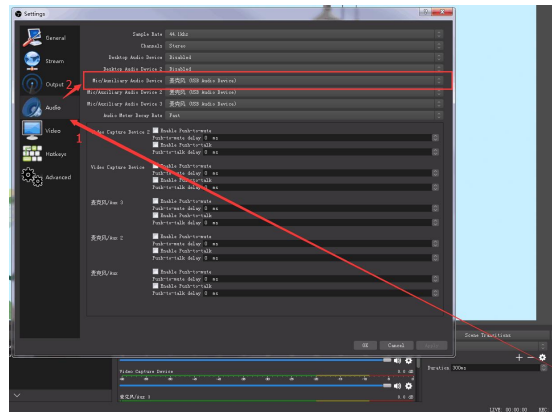

2. Right click the Video Capture Device in Source and choose Filter.

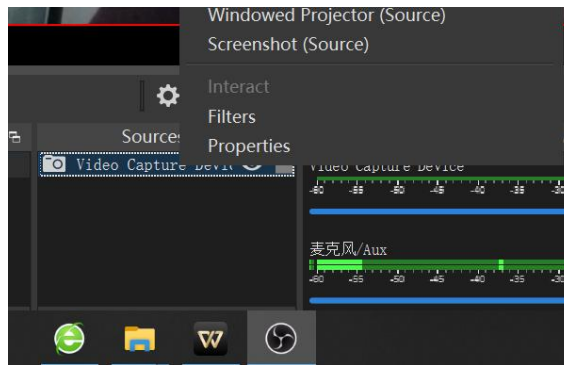

3. Click“+”under Audio/Video Filters and choose Video Delay (Async).

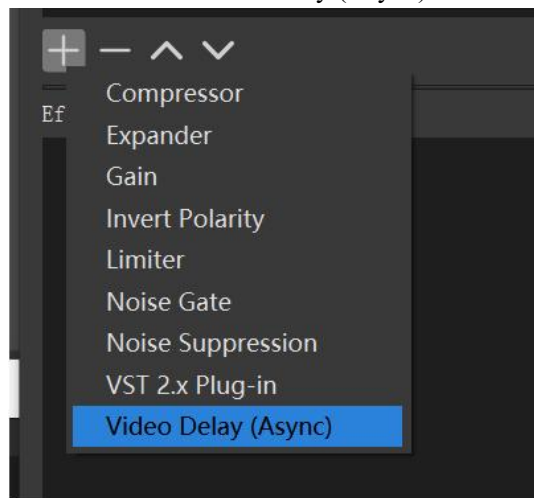

4. You can custom the filter name in the pop-up window. Click OK to confirm the filter name.

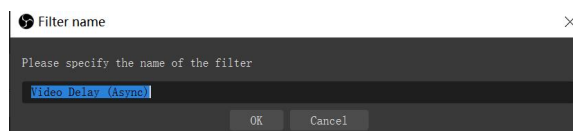

5. Input delay value in ms, the value need to adjusted until the video and audio is synchronous.



Streaming Setting

1. Find the RTMP URL and Stream Key provided by streaming broadcast website.
2. Copy URL and Stream Key.
3. Back to OBS, click Setting in the lower right corner and click “Stream”. Choose Stream Type as “Streaming Service” or “Custom Streaming Server” . If choose “Streaming Service”, there is a list of streaming service name available in the drop down list of Service. If the streaming service is in the list, choose it from the list.
If choose Custom Service, just fill in URL and Stream Key.

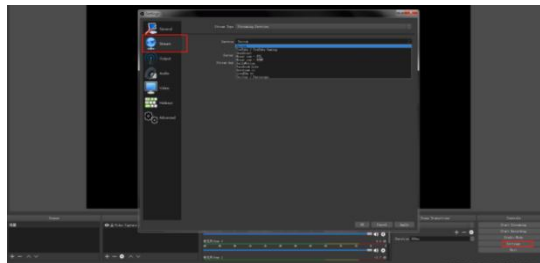

4. Paste the RTMP URL to Server or URL and Stream Key to Stream Key.
5. Click “Start Streaming”.
6. Go back to live broadcast website and check the broadcasting.

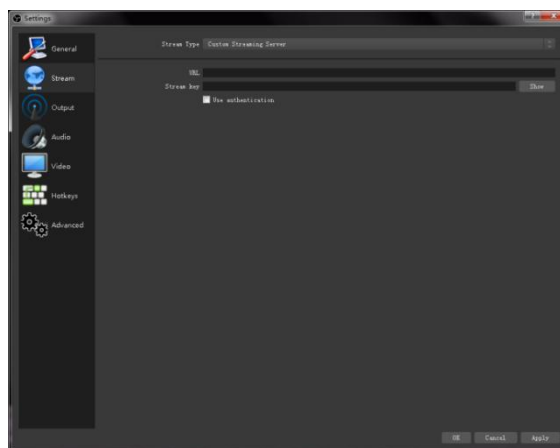

4.2 vMix Streaming

1. Click a new blank, then click the“Add Input” button.

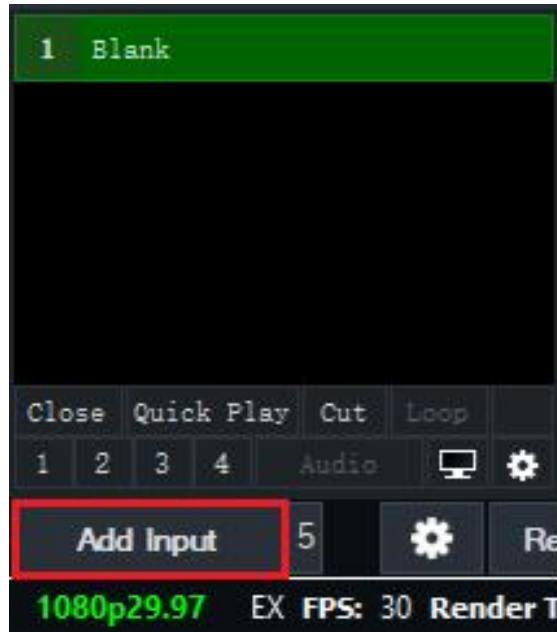

2. Select Camera-Camera-RGBlink USB3.0 Capture.

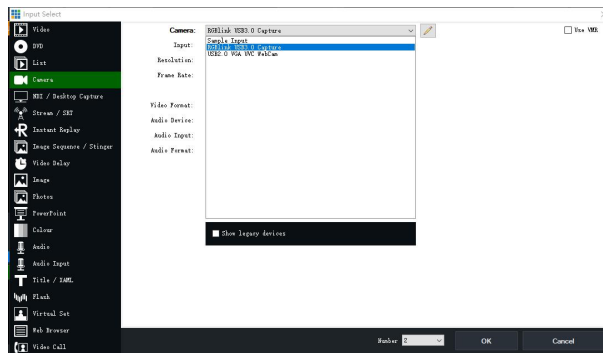

3. Select the same resolution as the mini output. Then click “OK”.

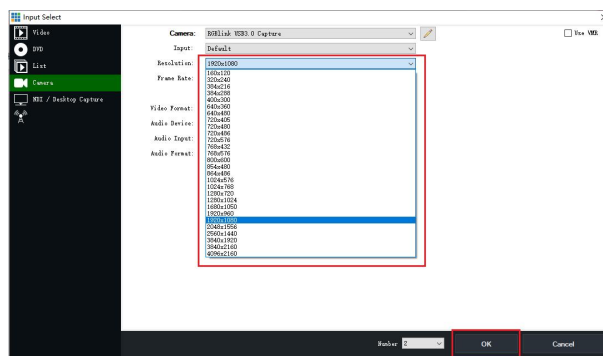

4. Click Stream setting button.



5. Complete the URL and Key information. Click“Start 1”, vMix will begin streaming.

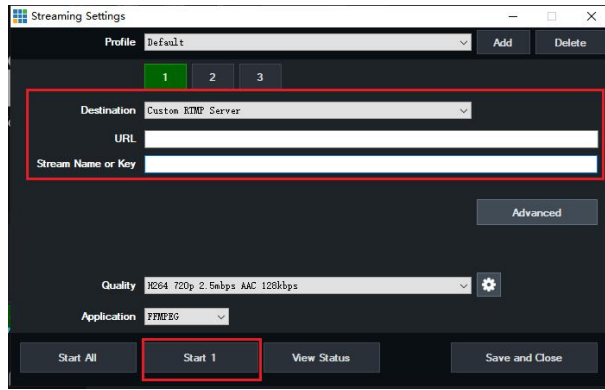

Note: vMix does not support automatic recognition of the output resolution of mini-pro. Every time the output resolution of mini-pro is modified, the picture on vMix will pause. The user needs to re-select RGBlink USB3.0 Capture and manually input the current output resolution of mini-pro.

4.3 Facebook Streaming

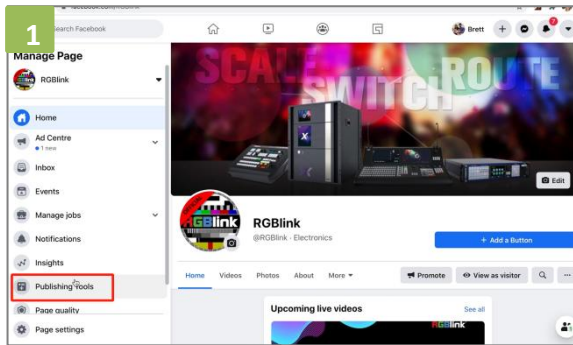

1. Enter "Publishing Tools".

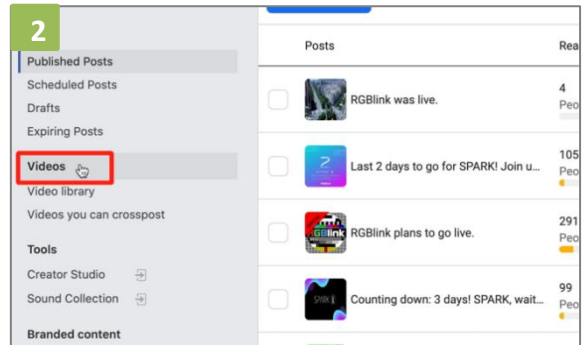

2. Click "Video".

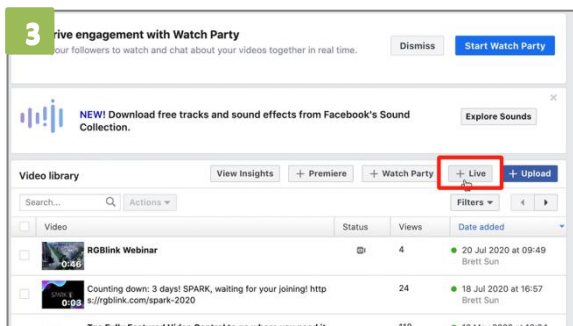

3. Click "+Live".

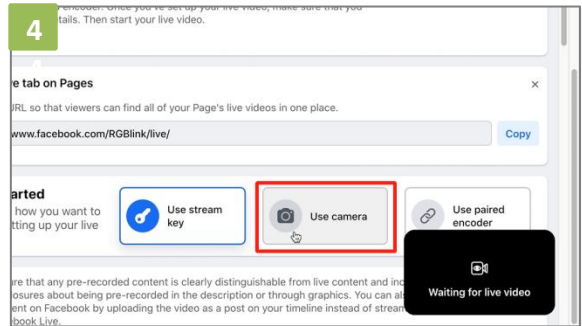

4. Choose "Use Camera".

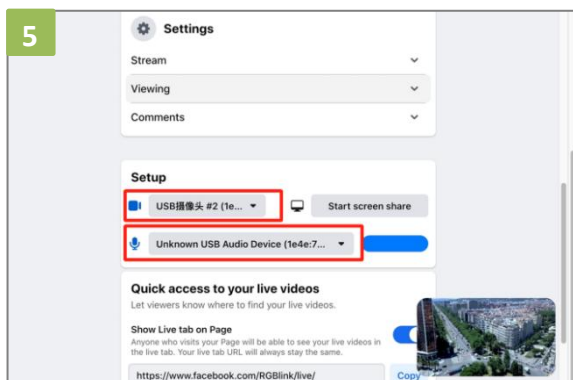

5. Set video and audio as USB 3.0 Video/Audio device.

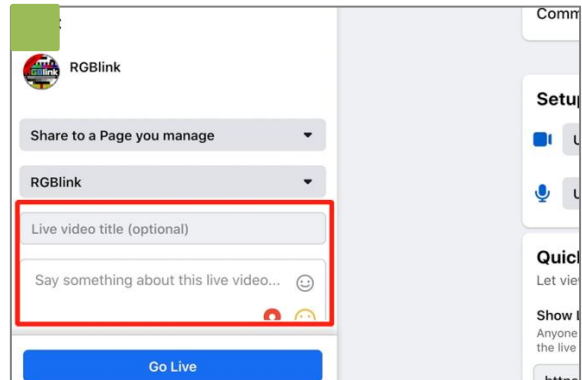

6. Add a title and description.

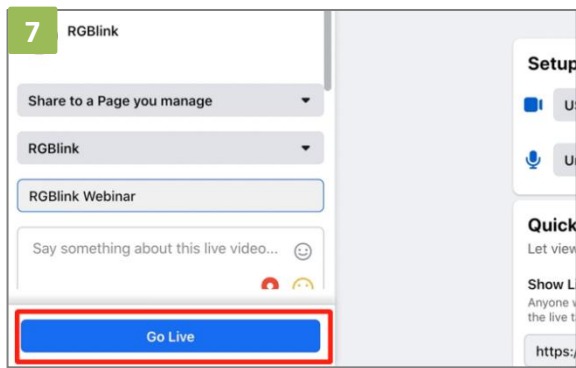

7. Go Live.

4.4 Zoom Streaming

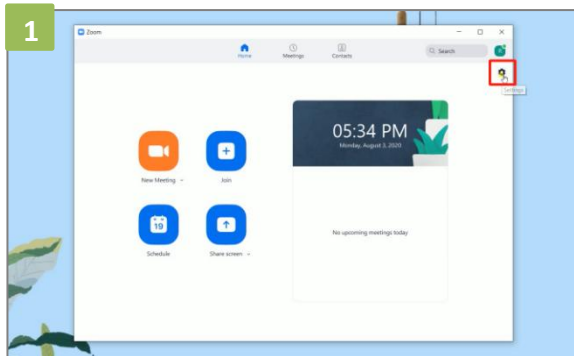

1. Enter Zoom, click "Setting" icon.

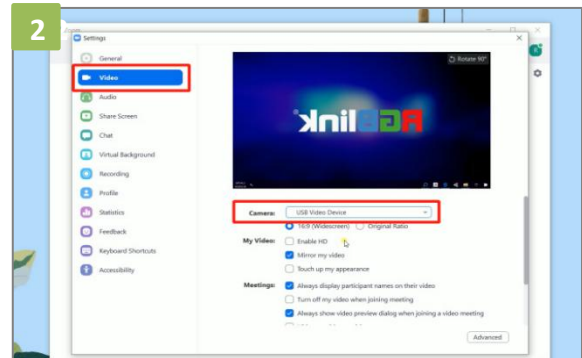

2. Click "Video", set Camera as "USB Video Device".

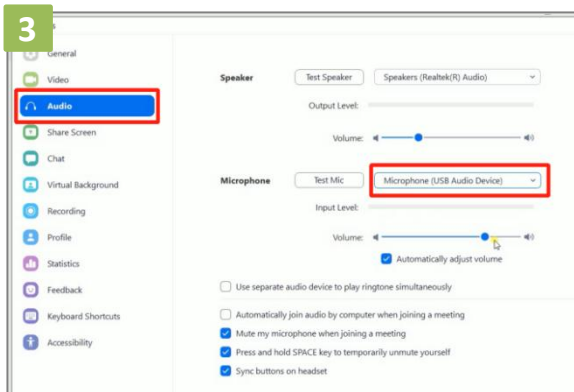

3. Click "Audio", set Microphone as "USB Audio Device".

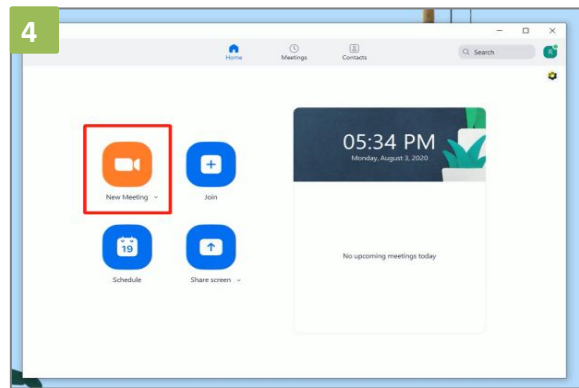

4. Finished all setting, Start meeting/Live.

Chapter 5 Ordering Codes

5.1 Product Code

230-0003-03-0

mini-pro

Chapter 6 Appendix

6.1 Specification

Connectors	Input	HDMI 4K	4×HDMI-A
	Output	HDMI 2K	2×HDMI-A
		Streaming	1×USB-A
		Recording	1×USB-A
	Audio	In	2×3.5mm Stereo Jack
		Out	1×3.5mm Stereo Jack
	Communication	LAN	1×RJ45
Power	Power Supply	1×USB-C	
Performance	Input Resolution	HDMI	1280×720p@50/60 1280×768p@60 1280×1024p@60 1360×768p@60 1366×768p@60 1600×900p@60 1920×1080i@50/60 1920×1080p@30/50/60 3840×2160p@23.97/24/25/29.97/30/50/59.94/60
	Output Resolution	HDMI	1280×720p@50/60 1920×1080p@24/30/50/60
	Standards	USB	1280×720p@60 1920×1080p@24/25/30/50/60
		HDMI	2.0
	Video	Video Formats	HDMI 2.0 HDCP 2.2
		Bit Depth	8 bit/10 bit/12 bit
		Color Space	RGB 8bit YUV 4:4:4 YUV 4:2:2 YUV 4:2:0
		Video Latency	<3 frames
	Audio	Audio Formats	LPCM/2ch/24bit/16bit/48kHZ
		Color Space	RGB 8bit
Record/Storage	Disk Formats	FAT32(≤32 GB) exFAT(64GB~2T)	
	Record Formats	MP4 (Code Rate:up to 16Mbps)	
Power	Input Voltage	PD 12V/2.5A(via plug pack supplied)	
	Max Power	20W	
Environment	Temperature	0°C~60°C	
	Humidity	10%~85%	
Physical	Weight	Net	0.42kg
		Packaged	1.20kg

	Dimension	Net	180.6mm×112.7mm×53mm
		Packaged	255mm×145mm×85mm

6.2 FAQ

1. When there is a problem with mini-pro.

A: We recommend you to reset and restart the device.

2. If there is a power supply problem with the mini-pro, or mini-pro failed to start, or the screen and buttons blinked frequently.

A: Please use the standard power adapter. If the above problem still occurs, try to replace the adapter (support PD 12V/2.5A and above).

3. mini-pro upgrade notes.

A: Please disable the other adapters(except mini-pro LAN adapter) on Network and Internet, turn off the DHCP on setting of mini-pro, after upgrading successfully, remember to reset and restart the device.

4. mini-pro cannot control PTZ.

A: Please make sure that the IP address of mini-pro and PTZ are in the same network segment. For example, the IP address of PTZ is 192.168.5.163. Please also set the IP address of mini-pro to 192.168.5.X (2~254) except 163 (Outside), confirm on mini XPOSE whether the Visca port number in the PTZ settings is the corresponding port number, for example, the Visca port number of the PTZ of RGBlink is 1259.

5. mini-pro USB 2.0 RECORD cannot recognize U disk.

A: Please format the U disk (exFAT, FAT32).

6. mini-pro USB 3.0 WEBCAM cannot be recognized/recognized without picture(black picture).

A: Please confirm whether the computer configuration meets the following conditions, if not, please select one of the following methods 6.1)-6.5) for testing:

Windows:

CPU:i5 and above

Memory:8 GB or more

Operating System: Windows 10 64 bit processor or above

Graphics: Support Direct X9 128M or above (open AERO effect)

Hard disk space: Above 16G (primary partitions, NTFS format)

Connector: USB 3.0 or type c

Others: do not run multiple video capture or editing software simultaneously

MAC:

CPU: i5 and above

Connector: USB 3.0 or type c

Operating System: macOS 11.0 Big Sur or later macOS 10.15 Catalina

Others: do not run multiple video capture or editing software simultaneously

6.1) Or use typeC to USB3.0 hub to connect the computer and mini-pro

6.2) Or use USB software->ProcessControl_1.0.0.2 to improve performance of computer(in the attachment)

6.3) Lower the output resolution

6.4) Unplug and plug the USB3.0 cable and re-enter the streaming software.

6.5) Change the USB3.0 cable to do streaming (note that the picture quality is lower than the USB3.0 cable, and the USB3.0 cable is not recommended to use the Preview output)

7. Does mini-pro support HDCP?

A: The HDMI input supports the HDCP protocol, HDMI input 1 port supports HDCP2.X, the other input ports support HDCP1.X, and the output does not support HDCP protocol encryption

8. mini-pro HDMI input what kind of YUV.

A: mini-pro supports 4:4:4, not supports 4:2:0.

9. When mini-pro input is i format signal will be half-screened or cut with the P format signal, the height of the P format will be cut.

A: At present, the latest program can automatically determine the i/P signal source and automatically adjust the cropping value.

10. Can mini-pro be controlled by mobile phone?

A: It is not supported by now.

11. When the mini-pro switch is turned on and power on, plug in the USB cable to USB2.0 RECORD port, and the LCD screen will sometimes flicker.

A: Hardware repair has been done, if this situation occurs, please try to turn off the switch, unplug the power, and power on again.

12. Can mini-pro recording be paused, If you stop recording and then start recording again, will it be saved in a new file?

A: Currently there is no pause function. Restarting recording will save a new file.

13. Can mini-pro control PTZ of Pelco protocol?

A: Currently, the PTZ controlling this protocol is not supported, mini-pro supports to control Visca protocol PTZ.

6.3 Upgrade

Online Upgrade

The mini pro supports online upgrade.

Upgrade Method: online upgrade

Steps:

1. Connect mini-pro and your PC via an Ethernet cable;
2. Open Network Settings on your PC and ensure that the PC has connected to the local area network where the device is located (such as enable DHCP to for auto IP address capture;
3. Tap "SETTING"> "Upgrade"to enter the following interface.

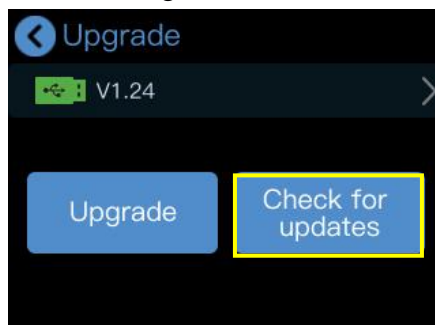

4. For no new version available, rotate knob to move the cursor to "Check for updates", then press the knob once again, the interface will display "Currently in the latest version".

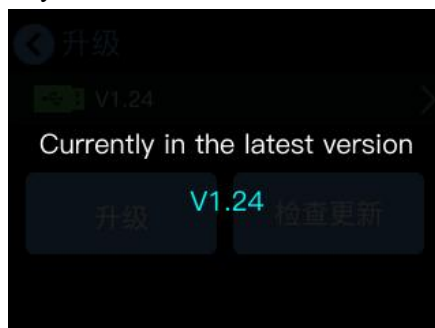

5. "New Version Available" indicates that new version has been captured.

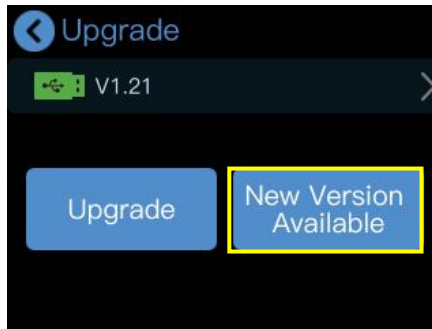

6. Tap "New Version Available" to check the new version discovered. Choose "Download and update" to download the firmware.

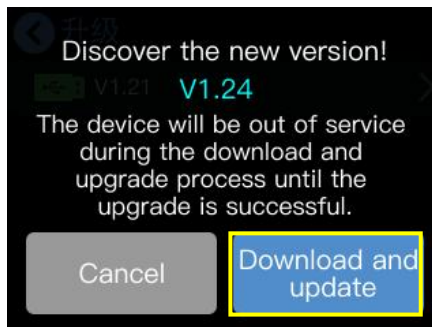

7. It takes about 10 minutes to download the file (depending on the network).

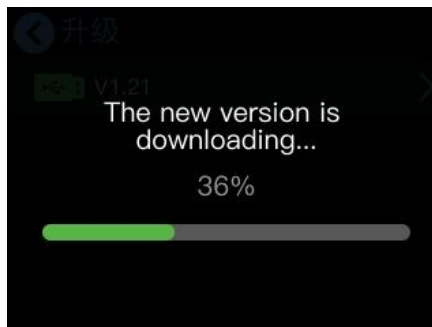

8. Tap "Confirm" to perform the upgrade process.

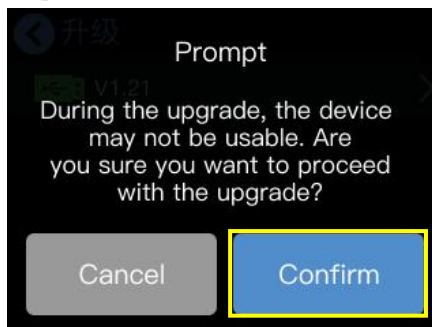

9. DO NOT power off during upgrade process. mini-edge will reboot after upgrade is completed.



10. Check the new version in the following interface.

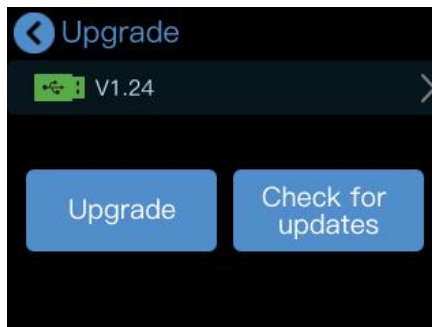

6.4 Terms & Definitions

- **RCA:** Connector used primarily in consumer AV equipment for both audio and video. The RCA connector was developed by the Radio Corporation of America.
- **BNC:** Stands for Bayonet Neill-Concelman. A cable connector used extensively in television (named for its inventors). A cylindrical bayonet connector that operates with a twist-locking motion .
- **CVBS:** CVBS or Composite video, is an analog video signal without audio. Most commonly CVBS is used for transmission of standard definition signals. In consumer applications the connector is typically RCA type, while in professional applications the connector is BNC type.
- **YPbPr:** Used to describe the colour space for progressive-scan. Otherwise known as component video.
- **VGA:** Video Graphics Array. VGA is an analog signal typically used on earlier computers. The signal is non-interlaced in modes 1, 2, and 3 and interlaced when using in mode.
- **DVI:** Digital Visual Interface. The digital video connectivity standard that was developed by DDWG (Digital Display Work Group). This connection standard offers two different connectors: one with 24 pins that handles digital video signals only, and one with 29 pins that handles both digital and analog video.
- **SDI:** Serial Digital Interface. Standard definition video is carried on this 270 Mbps data transfer rate. Video pixels are characterized with a 10-bit depth and 4:2:2 color quantization. Ancillary data is included on this interface and typically includes audio or other metadata. Up to sixteen audio channels can be transmitted. Audio is organised into blocks of 4 stereo pairs. Connector is BNC.
- **HD-SDI:** High-definition serial digital interface (HD-SDI), is standardized in SMPTE 292M this provides a nominal data rate of 1.485 Gbit/s.
- **3G-SDI:** Standardized in SMPTE 424M, consists of a single 2.970 Gbit/s serial link that allows replacing dual link HD-SDI.
- **6G-SDI:** Standardized in SMPTE ST-2081 released in 2015, 6Gbit/s bitrate and able to support 2160p@30.
- **12G-SDI:** Standardized in SMPTE ST-2082 released in 2015, 12Gbit/s bitrate and able to support 2160p@60.

-
- **U-SDI:** Technology for transmitting large-volume 8K signals over a single cable. a signal interface called the ultra high definition signal/data interface (U-SDI) for transmitting 4K and 8K signals using a single optical cable. The interface was standardized as the SMPTE ST 2036-4.
 - **HDMI:** High Definition Multimedia Interface: An interface used for the transmission of uncompressed high definition video, up to 8 channels of audio, and control signals, over a single cable.
 - **HDMI 1.3:** Released on June 22 2006, and increased the maximum TMDS clock to 340 MHz (10.2 Gbit/s). Support resolution 1920×1080 at 120 Hz or 2560×1440 at 60 Hz). It added support for 10 bpc, 12 bpc, and 16 bpc color depth (30, 36, and 48 bit/px), called deep color.
 - **HDMI 1.4:** Released on June 5, 2009, added support for 4096×2160 at 24 Hz, 3840×2160 at 24, 25, and 30 Hz, and 1920×1080 at 120 Hz. Compared to HDMI 1.3, 3 more features added which are HDMI Ethernet Channel (HEC) , audio return channel (ARC),3D Over HDMI, a new Micro HDMI Connector, an expanded set of color spaces.
 - **HDMI 2.0:** Released on September 4, 2013 increases the maximum bandwidth to 18.0 Gbit/s. Other features of HDMI 2.0 include up to 32 audio channels, up to 1536 kHz audio sample frequency, the HE-AAC and DRA audio standards, improved 3D capability, and additional CEC functions.
 - **HDMI 2.0a:** Was released on April 8, 2015, and added support for High Dynamic Range (HDR) video with static metadata.
 - **HDMI 2.0b:** Was released March, 2016, support for HDR Video transport and extends the static **metadata signaling to include Hybrid Log-Gamma (HLG).**
 - **HDMI 2.1:** Released on November 28, 2017. It adds support for higher resolutions and higher refresh rates, Dynamic HDR including 4K 120 Hz and 8K 120 Hz.
 - **DisplayPort:** A VESA standard interface primarily for video, but also for audio, USB and other data. DisplayPort (orDP) is backwards compatible with HDMI, DVI and VGA.
 - **DP 1.1:** Was ratified on 2 April 2007, and version 1.1a was ratified on 11 January 2008. DisplayPort 1.1 allow a maximum bandwidth of 10.8 Gbit/s (8.64 Gbit/s data rate) over a standard 4-lane main link, enough to support $1920 \times 1080 @ 60\text{Hz}$
 - **DP 1.2:** Introduced on 7 January 2010, effective bandwidth to 17.28 Gbit/s support increased resolutions, higher refresh rates, and greater color depth, maximum resolution $3840 \times 2160 @ 60\text{Hz}$
 - **DP 1.4:** Publish on 1 Mar, 2016. overall transmission bandwidth 32.4 Gbit/s ,DisplayPort 1.4 adds support for Display Stream Compression 1.2 (DSC), DSC is a "visually lossless" encoding technique with up to a 3:1 compression ratio. Using DSC with HBR3 transmission rates, DisplayPort 1.4 can support 8K UHD (7680×4320) at 60 Hz or 4K UHD (3840×2160) at 120 Hz with 30 bit/px RGB color and HDR. 4K at 60 Hz 30 bit/px RGB/HDR can be achieved without the need for DSC.
 - **Multi-mode Fiber:** Fibers that support many propagation paths or transverse modes are called multi-mode fibers, generally have a wider core diameter and are used for short-distance communication links and for applications where high power must be transmitted.
 - **Single-mode Fiber:** Fiber that support a single mode are called single-mode fibers. Single-mode fibers are used for most communication links longer than 1,000 meters (3,300 ft).
 - **SFP:** Small form-factor pluggable , is a compact, hot-pluggable network interface module used for both telecommunication and data communications applications.
 - **Optical Fiber Connector:** Terminates the end of an optical fiber, and enables quicker connection and disconnection than splicing. The connectors mechanically couple and align the cores of fibers so light can pass. 4 most common types of optical fiber connectors are SC, FC, LC,ST.

●**SC:** (Subscriber Connector), also known as the square connector was also created by the Japanese company – Nippon Telegraph and Telephone. SC is a push-pull coupling type of connector and has a 2.5mm diameter. Nowadays, it is used mostly in single mode fiber optic patch cords, analog, GBIC, and CATV. SC is one of the most popular options, as its simplicity in design comes along with great durability and affordable prices.

●**LC:** (Lucent Connector) is a small factor connector (uses only a 1.25mm ferrule diameter) that has a snap coupling mechanism. Because of its small dimensions, it is the perfect fit for high-density connections, XFP, SFP, and SFP+ transceivers.

●**FC:** (Ferrule Connector) is a screw type connector with a 2.5mm ferrule. FC is a round shaped threaded fiber optic connector, mostly used on Datacom, telecom, measurement equipment, single-mode laser.

●**ST:** (Straight Tip) was invented by AT&T and uses a bayonet mount along with a long spring-loaded ferrule to support the fiber.











●**USB:** Universal Serial Bus is a standard that was developed in the mid-1990s that defines cables, connectors and communication protocols. This technology is designed to allow a connection, communication and power supply for peripheral devices and computers.

●**USB 1.1:** Full-Bandwidth USB, specification was the first release to be widely adopted by the consumer market. This specification allowed for a maximum bandwidth of 12Mbps.

●**USB 2.0:** or Hi-Speed USB, specification made many improvements over USB 1.1. The main improvement was an increase in bandwidth to a maximum of 480Mbps.

● **USB 3.2:** Super Speed USB with 3 varieties of 3.2 Gen 1(original name USB 3.0), 3.2Gen 2(original name USB 3.1), 3.2 Gen 2x2 (original name USB 3.2) with speed up to 5Gbps,10Gbps,20Gbps respectively.

USB version and connectors figure:

	Type A	Type B	Mini A	Mini B	Micro-A	Micro-B	Type C
USB 2.0							
USB 3.0							
USB 3.1&3.2							

●**NTSC:** The colour video standard used in North America and some other parts of the world created by the National Television Standards Committee in the 1950s. NTSC utilizes an interlaced video signals.

●**PAL:** Phase Alternate Line. A television standard in which the phase of the colour carrier is alternated from line to line. It takes four full images (8 fields) for the colour-to-horizontal images (8 fields) for the colour-to-horizontal phase relationship to return to the reference point. This alternation helps cancel out phase errors. For this reason, the hue control is not needed on a PAL TV set. PAL, is widely used in needed on a PAL TV set. PAL, is widely used in Western Europe, Australia, Africa, the Middle East, and Micronesia. PAL uses 625-line, 50-field (25 fps) composite colour transmission system.

●**SMPTE:** Society of Motion image and Television Engineers. A global organization, based in the United States, that sets standards for baseband visual communications. This includes film as well as video and television standards.

-
- **VESA:** Video Electronics Standards Association. An organization facilitating computer graphics through standards.
 - **HDCP:** High-bandwidth Digital Content Protection (HDCP) was developed by Intel Corporation and is in wide use for protection of video during transmission between devices.
 - **HDBaseT:** A video standard for the transmission of uncompressed video (HDMI signals) and related features using Cat 5e/Cat6 cabling infrastructure.
 - **ST2110:** A SMPTE developed standard, ST2110 describes how to send digital video over and IP networks. Video is transmitted uncompressed with audio and other data in a separate streams. SMPTE2110 is intended principally for broadcast production and distribution facilities where quality and flexibility are more important.
 - **SDVoE:** Software Defined Video over Ethernet (SDVoE) is a method for transmission, distribution and management AV signals using a TCP/IP Ethernet infrastructure for transport with low latency. SDVoE is commonly used in integration applications.
 - **Dante AV:** The Dante protocol was developed for and widely adopted in audio systems for the transmission of uncompressed digital audio on IP based networks. The more recent Dante AV specification includes support for digital video.
 - **NDI:** Network Device interface (NDI) is a software standard developed by NewTek to enable video-compatible products to communicate, deliver, and receive broadcast quality video in a high quality, low latency manner that is frame-accurate and suitable for switching in a live production environment over TCP (UDP) Ethernet based networks. NDI is commonly found in broadcast applications.
 - **RTMP:** Real-Time Messaging Protocol (RTMP) was initially a proprietary protocol developed by Macromedia (now Adobe) for streaming audio, video and data over the Internet, between a Flash player and a server.
 - **RTSP:** The Real Time Streaming Protocol (RTSP) is a network control protocol designed for use in entertainment and communications systems to control streaming media servers. The protocol is used for establishing and controlling media sessions between end points.
 - **MPEG:** Moving Picture Experts Group is a working group formed from ISO and IEC developing standards that allow audio/video digital compression and Transmission.
 - **H.264:** Also known as AVC (Advanced Video Coding) or MPEG-4i is a common video compression standard. H.264 was standardized by the ITU-T Video Coding Experts Group (VCEG) together with the ISO/IEC JTC1 Moving Picture Experts Group (MPEG).
 - **H.265:** Also known as **HEVC** (High Efficiency Video Coding) H.265 is the successor to the widely used H.264/AVC digital video coding standard. Developed under the auspices of ITU, resolutions up to 8192x4320 may be compressed.
 - **API:** An Application Programming Interface (API) provides a predefined function which allows access capabilities and features or routines via a software or hardware, without accessing source code or understanding the details of inner working mechanism. An API call may execute a function and/or provide data feedback/report.
 - **DMX512:** The communication standard developed by USITT for entertainment and digital lighting systems. The wide adoption of the Digital Multiplex (DMX) protocol has seen the protocol used for a wide range of other devices including video controllers. DMX512 is delivered over cable of 2 twisted pairs with 5pin XLR cables for connection.
 - **ArtNet:** An ethernet protocol based on TCP/IP protocol stack, mainly used in entertainment/events applications. Built on the DMX512 data format, ArtNet enables multiple “universes” of DMX512 to be transmitted using ethernet networks for transport.
 - **MIDI:** MIDI is the abbreviation of Musical Instrument Digital Interface. As the name indicates the protocol was developed for communication between electronic musical instruments and latterly computers. MIDI instructions are triggers or commands sent over twisted pair cables, typically using 5pin DIN connectors.

●**OSC:** The principle of Open Sound Control (OSC) protocol is for networking sound synthesizers, computers, and multimedia devices for musical performance or show control. As with XML and JSON, the OSC protocol allows sharing data. OSC is transported via UDP packets between devices connected on an Ethernet.

●**Brightness:** Usually refers to the amount or intensity of video light produced on a screen without regard to colour. Sometimes called black level.

●**Contrast Ratio:** The ratio of the high light output level divided by the low light output level. In theory, the contrast ratio of the television system should be at least 100:1, if not 300:1. In reality, there are several limitations. Well-controlled viewing conditions should yield a practical contrast ratio of 30:1 to 50:1.

●**Colour Temperature:** The colour quality, expressed in degrees Kelvin (K), of a light source. The higher the colour temperature, the bluer the light. The lower the temperature, the redder the light. Benchmark colour temperature for the A/V industry include 5000°K, 6500°K, and 9000°K.

●**Saturation:** Chroma, Chroma gain. The intensity of the colour, or the extent to which a given colour in any image is free from white. The less white in a colour, the truer the colour or the greater its saturation. Saturation is the amount of pigment in a colour, and not the intensity.

●**Gamma:** The light output of a CRT is not linear with respect to the voltage input. The difference between what you should have and what is actually output is known as gamma.

●**Frame:** In interlaced video, a frame is one complete image. A video frame is made up of two fields, or two sets of interlaced lines. In a film, a frame is one still image of a series that makes up a motion image.

●**Genlock:** Allows synchronisation of otherwise video devices. A signal generator provides a signal pulses which connected devices can reference. Also see Black Burst and Color Burst.

●**Blackburst:** The video waveform without the video elements. It includes the vertical sync, horizontal sync, and the Chroma burst information. Blackburst is used to synchronize video equipment to align the video output.

●**Colour Burst:** In colour TV systems, a burst of subcarrier frequency located on the back part of the composite video signal. This serves as a colour synchronizing signal to establish a frequency and phase reference for the Chroma signal. Colour burst is 3.58 MHz for NTSC and 4.43 MHz for PAL.

●**Colour Bars:** A standard test pattern of several basic colours (white, yellow, cyan, green, magenta, red, blue, and black) as a reference for system alignment and testing. In NTSC video, the most commonly used colour bars are the SMPTE standard colour bars. In PAL video, the most commonly used colour bars are eight full field bars. On computer monitors the most commonly used colour bars are two rows of reversed colour bars.

●**Seamless Switching:** A feature found on many video switchers. This feature causes the switcher to wait until the vertical interval to switch. This avoids a glitch (temporary scrambling) which often is seen when switching between sources.

●**Scaling:** A conversion of a video or computer graphic signal from a starting resolution to a new resolution. Scaling from one resolution to another is typically done to optimize the signal for input to an image processor, transmission path or to improve its quality when presented on a particular display.

●**PIP:** Picture-In-Picture. A small image within a larger image created by scaling down one of image to make it smaller. Other forms of PIP displays include Picture-By-Picture (PBP) and Picture- With-Picture (PWP), which are commonly used with 16:9 aspect display devices. PBP and PWP image formats require a separate scaler for each video window.

●**HDR:** is a high dynamic range (HDR) technique used in imaging and photography to reproduce a greater dynamic range of luminosity than what is possible with standard digital imaging or photographic techniques. The aim is to present a similar range of luminance to that experienced through the human visual system.

●**UHD:** Standing for Ultra High Definition and comprising 4K and 8K television standards with a 16:9 ratio, UHD follows the 2K HDTV standard. A UHD 4K display has a physical resolution of 3840x2160 which is four times the area and twice both the width and height of a HDTV/FullHD (1920 x1080) video signal.

●**EDID:** Extended Display Identification Data. EDID is a data structure used to communicate video display information, including native resolution and vertical interval refresh rate requirements, to a source device. The source device will then output the provided EDID data, ensuring proper video image quality.

6.5 Revision History

The table below lists the changes to the User Manual.

Format	Time	ECO#	Description	Principal
V1.0	2024-03-21	0000#	Release mini-pro	Aster
V1.1	2024-05-06	0001#	Add Transition Effect illustration	Aster
V1.2	2024-07-06	0002#	Update Upgrade steps	Aster
V1.3	2025-01-10	0003#	Delete streaming via USB and add Steps of Streaming via Tao Cloud	Alyssa
V1.4	2025-01-21	0004#	Delete Upgrade Via XTOOL or U Disk	Alyssa
V1.5	2025-03-13	0005#	1.Update all known incorrect UI diagrams; 2.Modify all known format errors	Alyssa

All information herein is Xiamen RGBlink Science & Technology Co Ltd. excepting noted.

RGBlink is a registered trademark of Xiamen RGBlink Science & Technology Co Ltd.

While all efforts are made for accuracy at time of printing, we reserve the right to alter otherwise make change without notice.

Chapter 7 Support

www.rgblink.com



Inquiries
☎ +86-592-577-1197
✉ info@rgblink.com
🌐 rgblink.com/contact-us

Global Support
✉ support@rgblink.com
🌐 rgblink.com/support-me



@RGLINK /rgblink +rgblink /rgblink rgblink rgblink

RGblink Headquarters Xiamen · China

Room 601A, No. 37-3
Banshang community,
Building 3, Xinke Plaza, Torch
Hi-Tech industrialDevelopment
Zone, Xiamen,China

☎ +86 0592 577 1197

China Regional Sale & Support Shenzhen · China

705, 7th Floor, South District,
Building 2B, Skyworth
Innovation Valley, No. 1
Tangtou Road, Shiyuan Street,
Baoan District, Shenzhen City,
Guangdong Province

☎ +86 0755 2153 5149

Beijing Region Office Beijing · China

Room 33, 2nd Floor,
Building 1, National Defense
Science and Technology Park,
Zhongguancun Campus,
Beijing institute of
Technology, Haidian

☎ +010 8577 7286